



# USER MANUAL

## LRP-UN-G 12KW

### Premium Split-phase Hybrid Inverter



THIS MANUAL CONTAINS IMPORTANT SAFETY AND OPERATING INSTRUCTIONS FOR SOLAR CHARGE INVERTER.

YOU READ THIS MANUAL AND FOLLOW THE INSTRUCTIONS EXACTLY.

# Table of Contents

1.	Introduction .....	1
1-1.	System Overview .....	1
1-2.	Product Specifications .....	2
2.	Important Safety Warnings .....	3
3.	Unpacking & Overview .....	5
3-1.	Product Overview .....	5
3-2.	Packing List .....	6
4.	Installation .....	6
4-1.	Precautions .....	6
4-2.	Selecting the Mounting Location .....	6
4-3.	Mounting Unit .....	7
4-4.	Preparation .....	8
5.	Grid (Utility) Connection .....	9
5-1.	Preparation .....	9
5-2.	Connecting to the AC Utility .....	9
6.	Generator Connection .....	10
6-1.	Preparation .....	10
6-2.	Connecting to the Generator Input .....	10
7.	PV Module (DC) Connection .....	11
7-1.	Preparation .....	11
7-2.	Recommended Panel Configuration .....	12
8.	Battery Connection .....	13
9.	Load (AC Output) Connection .....	14
9-1.	Preparation .....	14
9-2.	Connecting to the AC output .....	14
10.	Rapid Shutdown (RSD) .....	15
11.	Communication .....	17
11-1.	Wi-Fi Connection .....	17
11-2.	Pin Assignment for RS-232 Communication Port .....	17
11-3.	Pin Assignment for BMS Communication Port .....	17
11-4.	Warning Codes .....	18
11-5.	Dry Contact Signal .....	18
12.	Commissioning .....	20
13.	Initial Setup .....	21
13-1.	Setting .....	21
13-2.	Grid-tie with Backup .....	23
13-3.	Grid-Tie .....	27
13-4.	Off-Grid .....	27
14.	Operation .....	31
14-1.	Interface .....	31
14-2.	LCD Information .....	31
14-3.	Touchable function keys .....	33
14-4.	SW ON/OFF Operation (located on the side of the inverter) .....	33
14-5.	LCD Setting .....	33
14-6.	Query Menu Operation .....	39
14-7.	Operation Mode & Display .....	43
15.	Charging Management .....	46
16.	Maintenance & Cleaning .....	48
17.	Trouble Shooting .....	49
18-1.	Warning List .....	49
18-2.	Fault Reference Codes .....	49
	Appendix I: Parallel Installation Guide .....	52
	Appendix II: The Wi-Fi Operation Guide .....	58
	Appendix III: The CT Operation Guide .....	67
	Appendix IV: The Generator Operation Guide .....	70

# 1. Introduction

## 1-1. System Overview

NOVA 12K can provide power to connected loads by utilizing PV power, utility power and battery power.

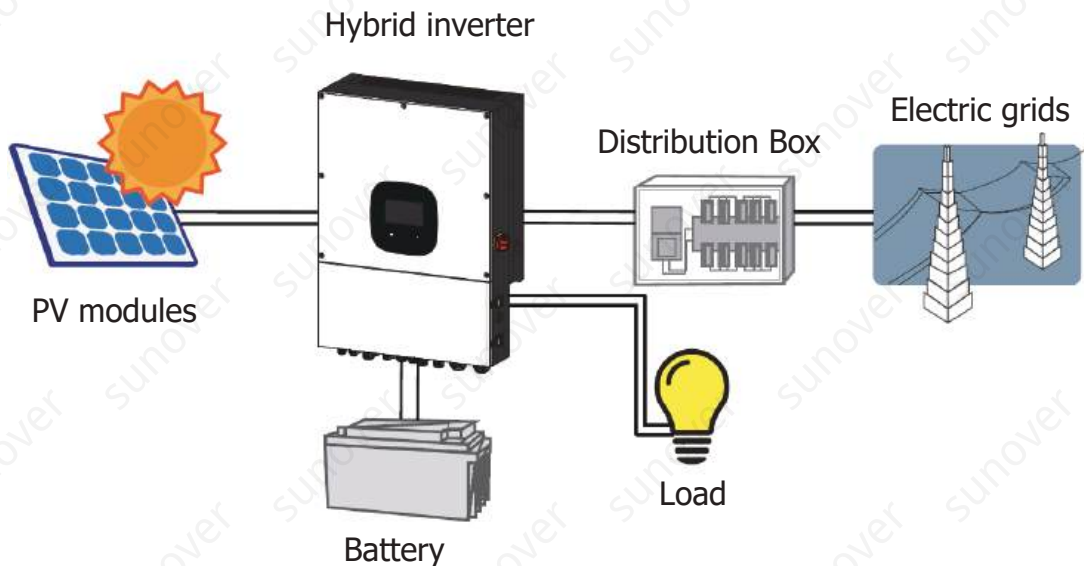

**Figure 1 Basic Hybrid PV System Overview**

Depending on different power situations, this hybrid inverter is designed to generate continuous power from PV solar modules (solar panels), battery, and the utility. When MPP input voltage of PV modules is within acceptable range (see specification for the details), this inverter is able to generate power to feed the grid (utility) and charge battery. This inverter is only compatible with PV module types of single crystalline and poly crystalline. Do not connect any PV array types other than these two types of PV modules to the inverter. Do not connect the positive or negative terminal of the solar panel to the ground.

## 1-2. Production Specifications

### NOVA 12K

Rated Power 10000 W

### PV INPUT (DC)

Maximum DC Power 12000 W

Nominal DC Voltage 360 VDC

Maximum DC Voltage 600 VDC

Working DC Voltage Range 120 VDC ~ 550 VDC

Start-up Voltage / Initial Feeding Voltage 125 VDC / 160 VDC

MPP Voltage Range / Full Load MPP Voltage Range 120 VDC ~ 550 VDC

Maximum Input Current 2 x 18 A (MAX 30 A)

Isc PV (absolute maximum) 2 x 18 A (MAX 30 A)

Max. inverter back feed current to the array 0 A

### GRID OUTPUT (AC)

Nominal Output Voltage 120 VAC (P-N) / 208 VAC (P-P)/ 240 VAC(P-P)

Output Voltage Range 105.5 - 132 VAC per phase

Output Frequency Range 47.5 ~ 51.5 Hz or 59.3~ 60.5Hz

Nominal Output Current 41.7A per phase

Inrush Current/Duration 50 A per phase / 20ms

Maximum Output Fault Current/Duration 90 A per phase / 1ms

Maximum Output Overcurrent Protection 90 A per phase

Power Factor Range 0.9 lead – 0.9 lag

### AC INPUT

AC Start-up Voltage 85 VAC per phase

Auto Restart Voltage 90 VAC per phase

Acceptable Input Voltage Range 85 - 140 VAC per phase

Nominal Frequency 50 Hz / 60 Hz

AC Input Power 10000VA/10000W

Maximum AC Input Current 60 A

Inrush Input Current 60 A / 1ms

### BATTERY MODE OUTPUT (AC)

Nominal Output Voltage 120 VAC (P-N) / 208 VAC (P-P)/ 240 VAC(P-P)

Output Frequency 50 Hz / 60 Hz (auto sensing)

Output Waveform Pure sine wave

Output Power 10000VA/10000W

Efficiency (DC to AC) 91%

### BATTERY & CHARGER (Lead-acid/Li-ion)

DC Voltage Range 40 – 62 VDC

Nominal DC Voltage 48 VDC

Maximum Battery Discharging Current 200 A

Maximum Charging Current 200 A

### GENERAL

#### PHYSICAL

Dimension, D X W X H (mm) 215.5 x 515 x 715

Net Weight (kgs) 51

#### INTERACE

Communication Port RS-232/USB

Intelligent Slot RS232/USB,BMS, WIFI

#### ENVIRONMENT

Protective Class I

Ingress Protection Rating IP65

Humidity 0 ~ 90% RH (No condensing)

Operating Temperature -25 to 60°C (Power derating above 45°C)





Altitude Max. 2000m\*

\* Power derating 1% every 100m when altitude is over 1000m.

## 2. Important Safety Warnings

Before using the inverter, please read all instructions and cautionary markings on the unit and this manual. Store the manual where it can be accessed easily. This manual is for qualified personnel. The tasks described in this manual can only be performed by qualified personnel.





### Symbols used in Equipment Markings

	Refer to the operating instructions
	Caution! Risk of danger
	Caution! Risk of electric shock
	Caution! Risk of electric shock. Energy storage timed discharge for 5 minutes.
	Caution! Hot surface

### Conventions used in this Document

<b>WARNING!</b>	Warnings identify conditions or practices that could result in personal injury;
<b>CAUTION!</b>	Cautions identify conditions or practices that could result in damaged to the unit or other equipment connected.

### General Precautions

	<b>WARNING!</b> Before installing and using this inverter, read all instructions and cautionary markings on the inverter and all appropriate sections of this guide.
	<b>WARNING!</b> Normally grounded conductors may be ungrounded and energized when a ground fault is indicated.
	<b>WARNING!</b> This inverter is heavy. It should be lifted by at least two people.
	<b>CAUTION!</b> Authorized service personnel should reduce the risk of electrical shock by disconnecting AC, DC and battery power from the inverter before attempting any maintenance, cleaning or working on any circuits connected to the inverter. Turning off controls will not reduce this risk. Internal capacitors can remain charged for 5 minutes after disconnecting all sources of power.



**CAUTION!** Do not disassemble this inverter yourself. It contains no user-serviceable parts. Attempt to service this inverter yourself may cause a risk of electrical shock or fire and will void the warranty from the manufacturer.



**CAUTION!** To avoid a risk of fire and electric shock, make sure that existing wiring is in good condition and that the wire is not undersized. Do not operate the Inverter with damaged or substandard wiring.



**CAUTION!** Under high temperature environment, the cover of this inverter could be hot enough to cause skin burns if accidentally touched. Ensure that this inverter is away from normal traffic areas.



**CAUTION!** Use only recommended accessories from installer. Otherwise, not-qualified tools may cause a risk of fire, electric shock, or injury to persons.



**CAUTION!** To reduce risk of fire hazard, do not cover or obstruct the cooling fan.



**CAUTION!** Do not operate the Inverter if it has received a sharp blow, been dropped, or otherwise damaged in any way. If the Inverter is damaged, please call for an RMA (Return Material Authorization).



**CAUTION!** AC breaker, DC switch and Battery circuit breaker are used as disconnect devices and these disconnect devices shall be easily accessible.



**WARNING!** Risk of Voltage Backfeed. Before working on this circuit, isolate inverter/Uninterruptible Power System (UPS); then check for Hazardous Voltage between all terminals including the protective earth.

### 3. Unpacking & Overview

#### 3-1. Product Overview

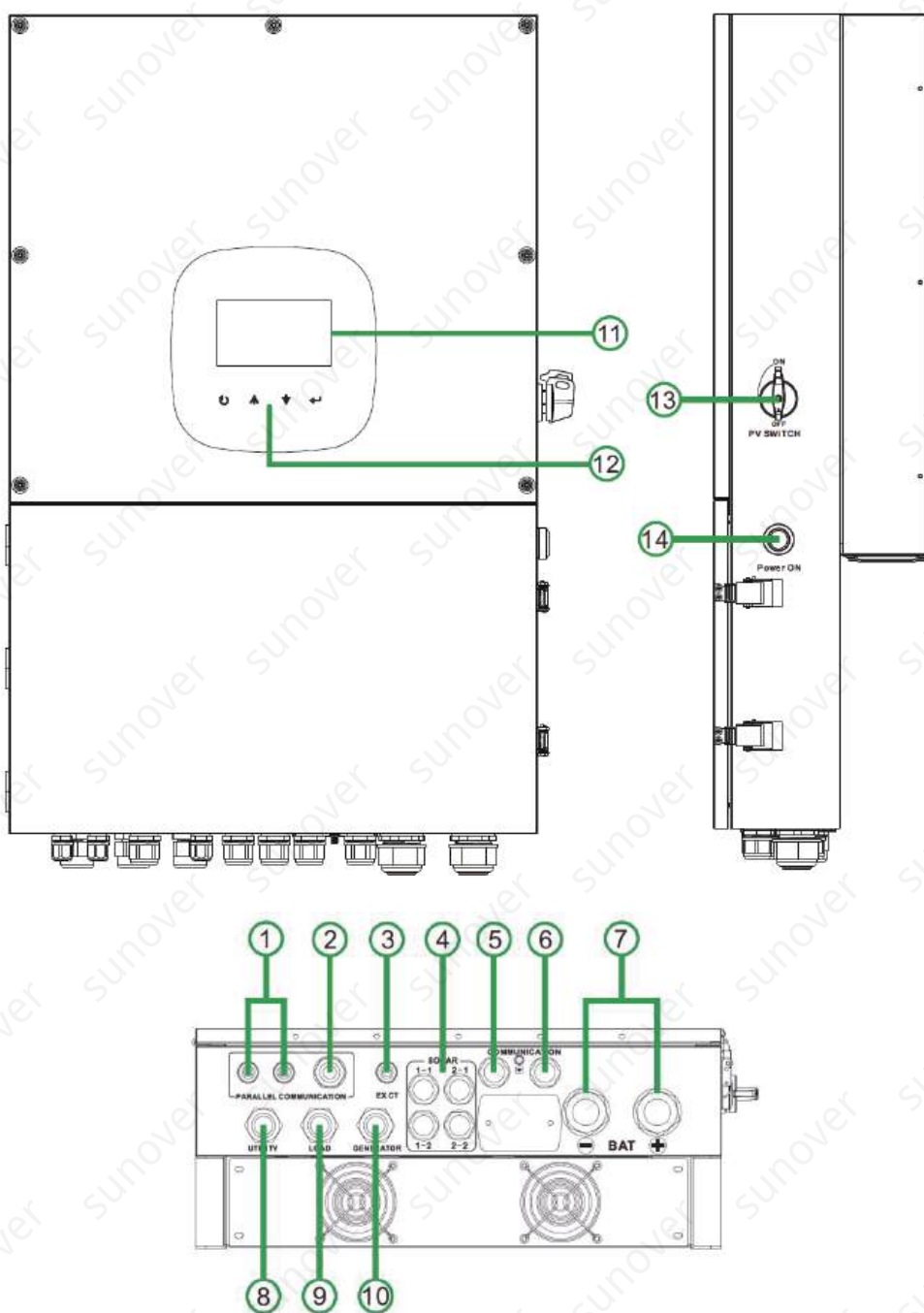

- ① Current sharing port
- ② Parallel communication port
- ③ External sensor port (reserved)
- ④ PV Connectors
- ⑤ Dry contact & USB communication port
- ⑥ BMS & RS-232 communication port Dry contact & USB communication port
- ⑦ Battery connectors
- ⑧ AC Grid connectors
- ⑨ AC Output connectors (Load connection)
- ⑩ Generator input
- ⑪ LCD display panel (Please check section 10 for detailed LCD operation)
- ⑫ Operation buttons
- ⑬ PV switch
- ⑭ Power on/off switch

## 3-2. Packing List

Before installation, please inspect the unit. Be sure that nothing inside the package is damaged. You should have received the following items inside of package:

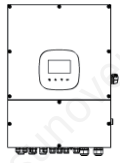

Inverter unit



RS-232 cable

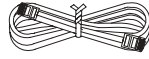

Parallel cable



Share current wires

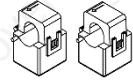

CT



Manual



Software CD



Fixing screws



Wi-Fi antenna

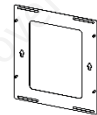

Wall mount bracket

## 4. Installation

### 4-1. Precautions

This hybrid inverter is designed for indoor or outdoor use (IP65), please make sure the installation site meets the following conditions:

- Not in direct sunlight
- Not exposed during rain or snow
- Not in areas where highly flammable materials are stored.
- Not in potential explosive areas.
- Not in the cool air directly.
- Not near the television antenna or antenna cable.
- Not higher than altitude of about 2000 meters above sea level.
- Not in environment of precipitation or humidity (>95%).

### 4-2. Selecting the Mounting Location

- Please select a vertical wall with load-bearing capacity for installation and install on a concrete or other non-flammable surface.
- The ambient temperature should be between -25~60°C to ensure optimal operation.
- Be sure to keep other objects and surfaces as shown in the diagram to guarantee sufficient heat dissipation and enough space for removing wires.
- For proper air ventilation to dissipate heat, allow a clearance of approx. 50cm to the sides, approx. 50cm above and below the unit, and 100cm toward the front.



**WARNING! FIRE HAZARD. ONLY SUITABLE FOR MOUNTING ON CONCRETE OR OTHER NON-COMBUSTIBLE SURFACE.**

## 4-3. Mounting Unit



**WARNING!** Remember that this inverter is heavy! Please be careful when lifting it out from the package.

Installation to the wall should be implemented with the proper screws. After that, the device should be bolted on securely.

The inverter only can be used in a **CLOSED ELECTRICAL OPERATING AREA**. Only service people can enter into this area.

1.

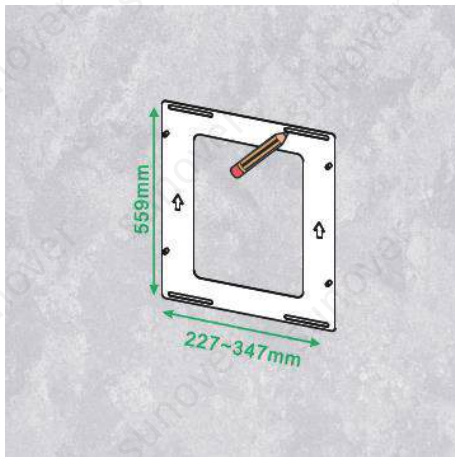

2.

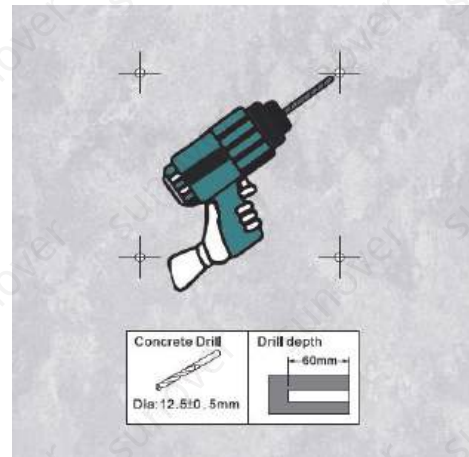

3.

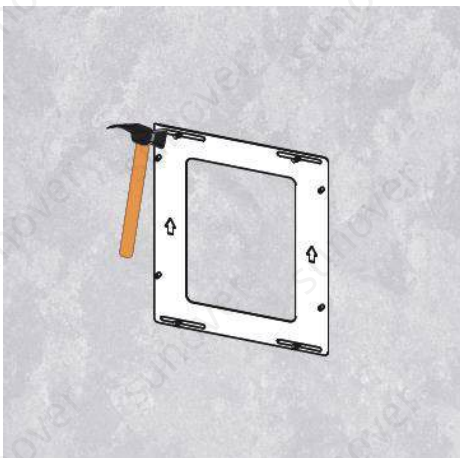

4.

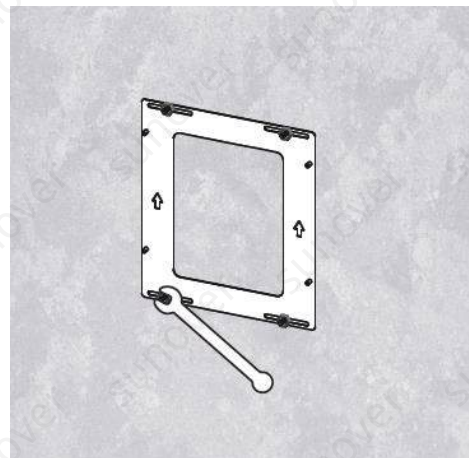

5.



6.



## 4-4. Preparation

Before connecting all wires, be sure to take off wiring cover by removing the four screws. Refer to chart below for the details.

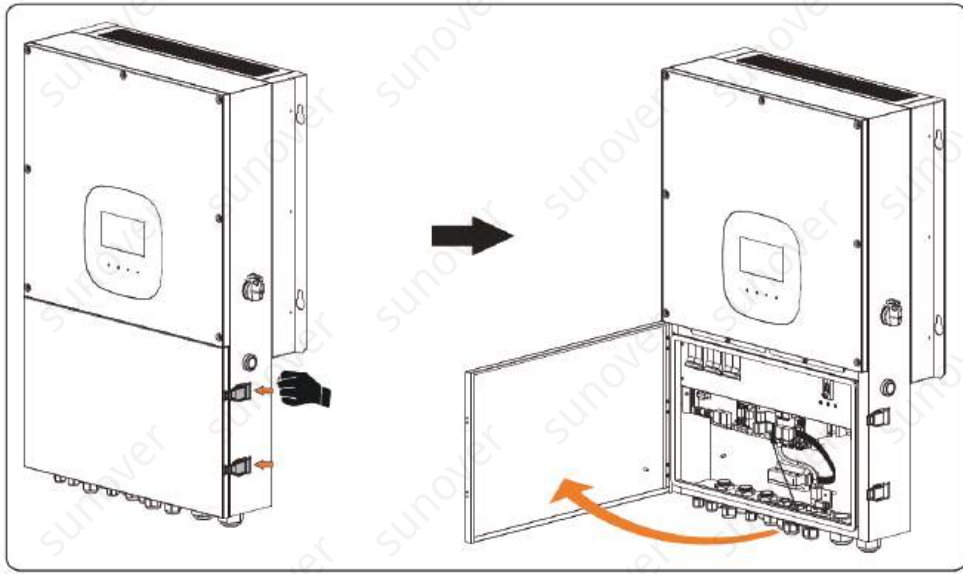

Overview of the cable box

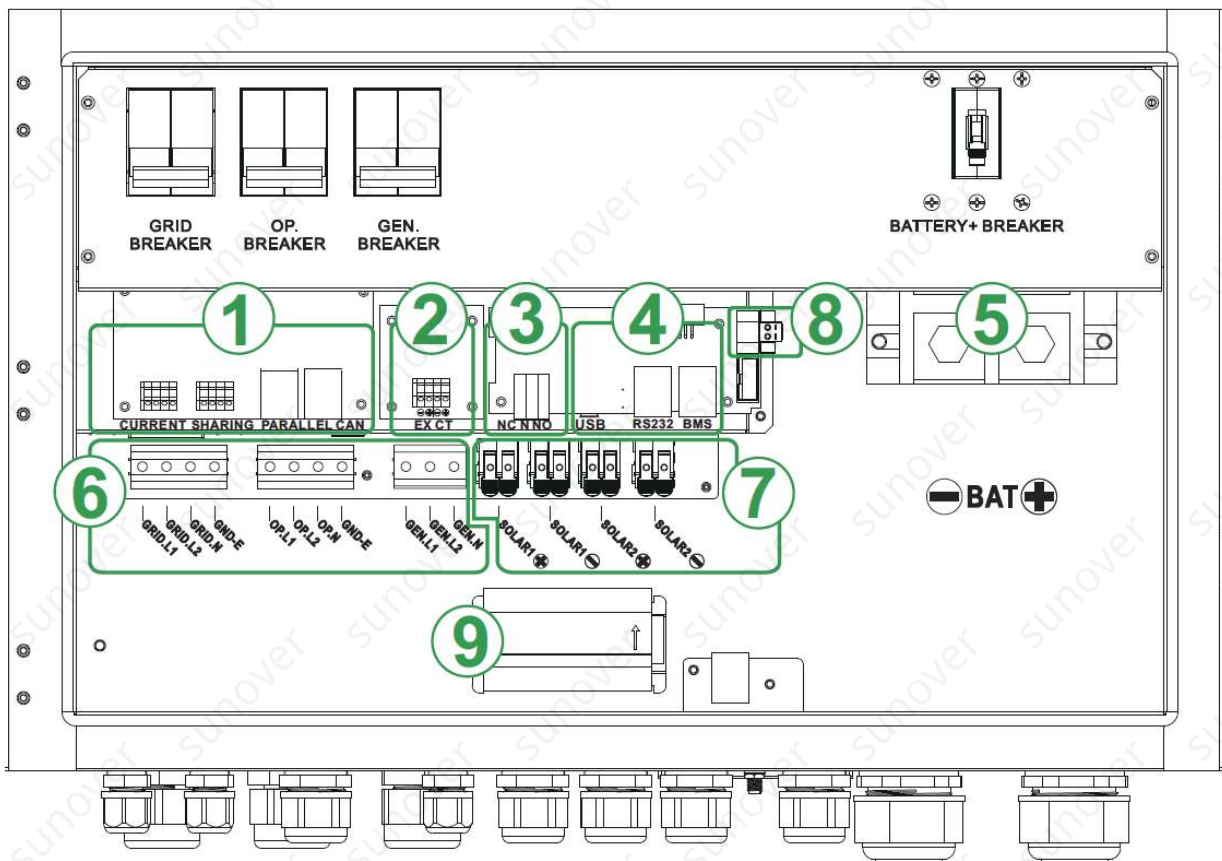

- |                        |                      |                    |
|------------------------|----------------------|--------------------|
| ① Current sharing port | ④ Communication port | ⑦ PV Terminals     |
| ② External CT          | ⑤ Battery Terminals  | ⑧ Rapid shutdown   |
| ③ Dry contact          | ⑥ AC Terminals       | ⑨ Arc fault device |

## 5. Grid (Utility) Connection

### 5-1. Preparation

**NOTE 1:** The overvoltage category of the AC input is III. It should be connected to the power distribution.

**NOTE 2:** Before connecting to grid, please install a separate AC breaker between inverter and grid. This will ensure the inverter can be securely disconnected during maintenance and fully protected from over current. The **recommended AC breaker is 60A/300V**.



**WARNING!** It's very important for system safety and efficient operation to use appropriate cable for grid (utility) connection. To reduce the risk of injury, please use the recommended cable size.

### Recommended Cable for AC Wire

Nominal Grid Voltage	120VAC per phase
Conductor cross-section (mm <sup>2</sup> )	10-16
AWG no.	8-6

### 5-2. Connecting to the AC Utility

Please follow below steps to implement AC input connection:

1. Before making AC input connection, be sure to first open the DC protector or disconnecter.

2. Remove 7mm of the insulation sleeve for the four conductors.



3. Insert AC input wires according to the polarities indicated on the terminal block and tighten the terminal screws. Be sure to connect the PE protective conductor (⊕) first.

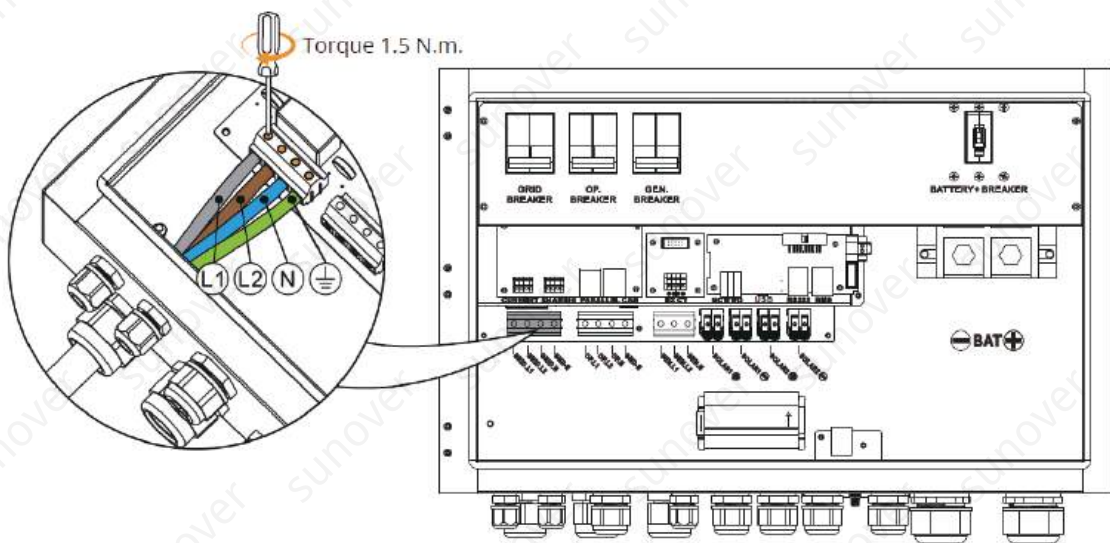

**WARNING!** Be sure that AC power source is disconnected before attempting to hardwire it to the unit.

## 6. Generator Connection

### 6-1. Preparation

**NOTE 1:** The overvoltage category of the AC input is III. It should be connected to the power distribution.

**NOTE 2:** Before connecting to grid, please install a separate AC breaker between inverter and grid. This will ensure the inverter can be securely disconnected during maintenance and fully protected from over current. The **recommended AC breaker is 60A/300V**.



**WARNING!** It's very important for system safety and efficient operation to use the appropriate cable for generator connection. To reduce the risk of injury, please use the recommended cable size.

### Recommended cable size

Nominal Grid Voltage	120VAC per phase
Conductor cross-section (mm <sup>2</sup> )	10-16
AWG no.	8-6

### 6-2. Connecting to the Generator Input

Please follow the steps below to implement the generator input connection:

1. Before making generator input connection, be sure to first open the DC protector or disconnecter.
2. Remove 7mm of the insulation sleeve. 
3. Insert the input wires according to the polarities indicated on terminal block and tighten the terminal screws. Be sure to connect the PE protective conductor (⊕) first.

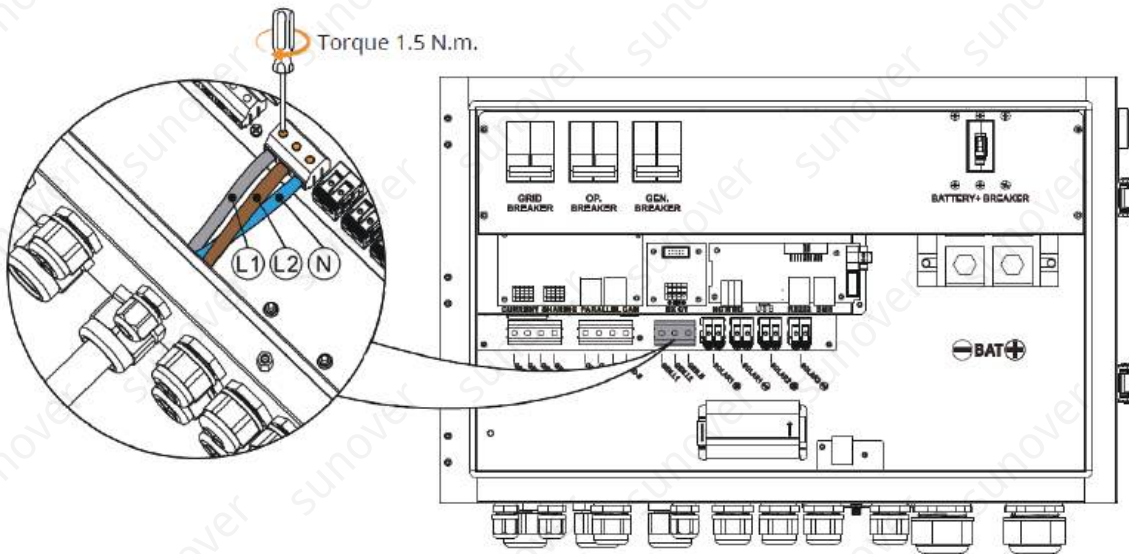

**WARNING!** Be sure that the generator power source is disconnected before attempting to hardwire it to the unit.

## 7. PV Module (DC) Connection

### 7-1. Preparation

**NOTE1:** Before connecting to the PV modules, please **separately** install a DC circuit breaker between the inverter and the PV modules. Please use a **1000VDC/20A circuit breaker**.

**NOTE2:** The overvoltage category of the PV input is II.



**WARNING!** Because this inverter is non-isolated, only two types of PV modules are acceptable: single crystalline and poly crystalline with class A-rated. To avoid any malfunction, do not connect any PV modules with the possibility of leakage current to the inverter. For example, grounded PV modules will cause leakage current to the inverter.



**CAUTION:** It's requested to have PV junction box with surge protection. Otherwise, it will cause inverter damage when lightning occurs on the PV modules.



**WARNING!** It's very important for system safety and efficient operation to use the appropriate cable for PV module connection. To reduce the risk of injury, please use the recommended cable size.

#### Recommended cable size

Conductor cross-section (mm <sup>2</sup> )	AWG no.
4	12

Please follow below steps to implement PV module connection:

1. Check the input voltage of PV array modules. The acceptable input voltage of the inverter is 120VDC - 600VDC. This system is applied with two strings of PV array. Please make sure that the maximum current load of each PV input connector is 18A.

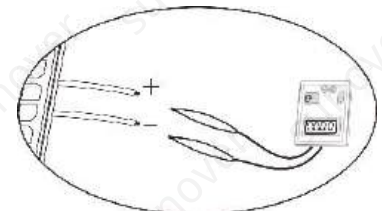

**CAUTION:** Exceeding the maximum input voltage can destroy the unit!! Check the system before wire connection.

2. Disconnect the circuit breaker and switch off the DC switch.
3. Remove 7mm of the insulation sleeve.
4. Check correct polarity of connection cable from PV modules and PV input connectors.



Note: Product provide arc detection to ensure the safety of users' lives and property.

Only PV positive wire necessary AFD connected to terminals.

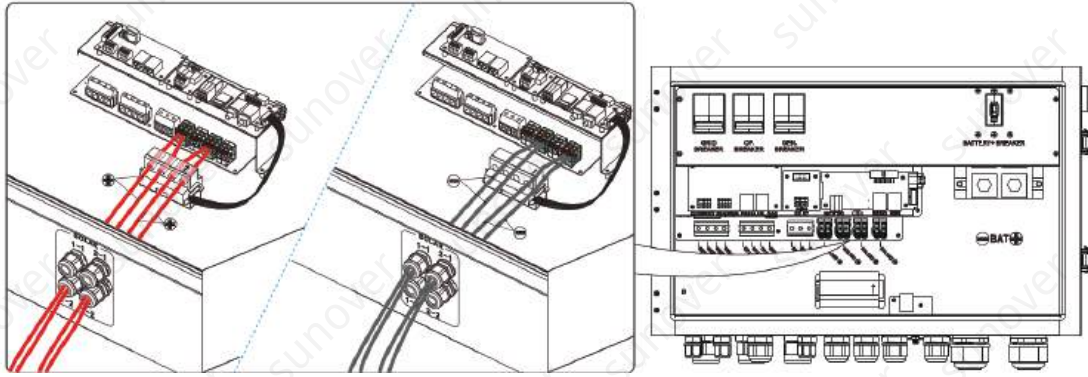

**CAUTION:** Never directly touch terminals of the inverter. It will cause lethal electric shock. Do NOT touch the inverter to avoid electric shock. When PV modules are exposed to sunlight, it may generate DC voltage to the inverter.

## 7-2. Recommended Panel Configuration

Specifications	Solar panel			
Nominal Max. Power (Pmax) (W)	520	535	560	580
Opt. Operating Voltage (Vmp) (V)	41.6	41.9	44.31	44.78
Opt. Operating Current (Imp) (A)	12.5	12.77	12.64	12.96
Open Circuit Voltage (Voc) (V)	49.14	49.44	52.90	53.30
Short Circuit Current (Isc) (A)	13.23	13.5	13.50	13.82
For 12KW input recommendation				
<b>Numbers in series of MPPT1</b>	<b>11</b>	<b>11</b>	<b>10</b>	<b>10</b>
<b>Numbers of strings in MPPT1</b>	<b>1</b>	<b>1</b>	<b>1</b>	<b>1</b>
Maximum input voltage of MPPT1 (V)	540.5	543.8	529	533
Input power of MPPT1 (W)	5720	5885	5600	5800
<b>Numbers in series of MPPT2</b>	<b>11</b>	<b>11</b>	<b>10</b>	<b>10</b>
<b>Numbers of strings in MPPT2</b>	<b>1</b>	<b>1</b>	<b>1</b>	<b>1</b>
Maximum input voltage of MPPT1 (V)	540.5	543.8	529	533
Input power of MPPT2 (W)	5720	5885	5600	5800
Total input power (W)	11440	11770	11200	11600
Minimum input recommendation				
<b>Numbers in series of MPPT1</b>	<b>4</b>	<b>4</b>	<b>4</b>	<b>4</b>
<b>Numbers of strings in MPPT1</b>	<b>1</b>	<b>1</b>	<b>1</b>	<b>1</b>
Maximum input voltage of MPPT1 (V)	196.6	197.6	211.6	213.2
Input power of MPPT1 (W)	2080	2140	2240	2320
<b>Numbers in series of MPPT2</b>	<b>4</b>	<b>4</b>	<b>4</b>	<b>4</b>
<b>Numbers of strings in MPPT2</b>	<b>1</b>	<b>1</b>	<b>1</b>	<b>1</b>
Maximum input voltage of MPPT1 (V)	196.6	197.6	211.6	213.2
Input power of MPPT2 (W)	2080	2140	2240	2320
Total input power (W)	4160	4280	4480	4640

## 8. Battery Connection

**NOTE1:** Before connecting to batteries, please install **separately** a DC circuit breaker between inverter and batteries. Please use **60VDC/250A circuit breaker**.

**NOTE2:** Please only use sealed lead acid battery, vented and Gel battery. Please check the maximum charging voltage and current when first using this inverter. If using a Lithium iron or Nicd battery, please consult with installer for the details.

**NOTE3:** The overvoltage category of the battery input is II.

### Recommended battery cable and terminal size for each inverter

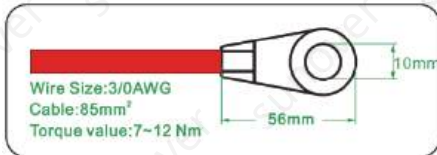

Please follow below steps to implement battery connection:

1. Check the nominal voltage 48VDC of batteries.

2. Remove 10mm of the insulation sleeve.



**WARNING!** Be sure the length of all battery cables are the same. Otherwise, there will be a voltage difference between inverter and battery and cause parallel inverters to not work.

3. Insert battery wires according to polarities indicated on the terminal block and tighten the terminal screws.

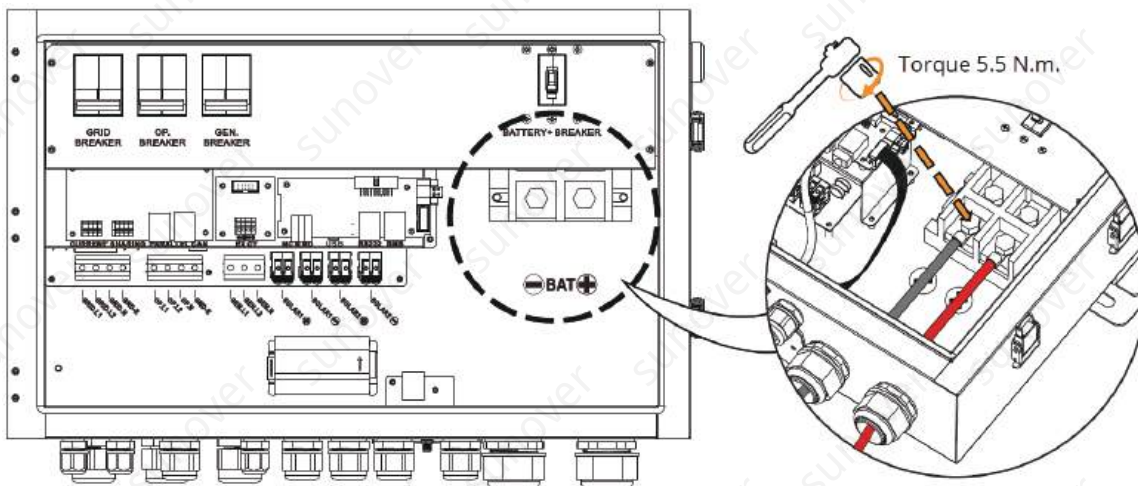

**RED** cable to the positive terminal (+);

**BLACK** cable to the negative terminal (-).



**WARNING!** Wrong connections will damage the unit permanently.

## 9. Load (AC Output) Connection

### 9-1. Preparation

**NOTE1:** To prevent further supply to the load via the inverter during any mode of operation, an additional disconnection device should be placed on in the building wiring installation.



**WARNING!** It's very important for system safety and efficient operation to use the appropriate cable for AC connection. To reduce the risk of injury, please use the recommended cable size.

### Recommended Cable Size

Nominal Grid Voltage	120/208/240 VAC per phase
Conductor cross-section (mm <sup>2</sup> )	10-16
AWG no.	8-6

### 9-2. Connecting to the AC output

1. Before making output connection, be sure to first open the DC protector or disconnecter.
2. Remove 7mm of the insulation sleeve. 
3. Insert AC input wires according to the polarities indicated on terminal block and tighten the terminal screws. Be sure to connect the PE protective conductor (⊕) first.

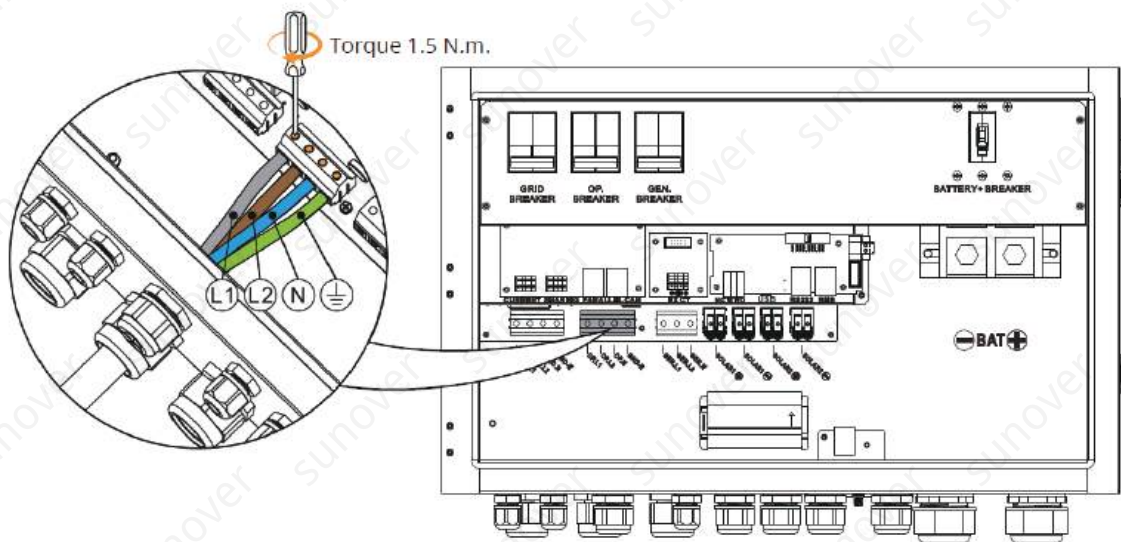

**CAUTION:** Do NOT connect the utility to "AC Output Connector (Load connector)". Be sure to connect the L terminal of load to the L terminal of "AC Output Connector (Load connector)" and the N terminal of load to the N terminal of "AC Output Connector (Load connector)". The G terminal of "AC Output Connector" is connected to grounding of the load.



**CAUTION:** Appliances such as air conditioner require at least 2~3 minutes to restart because it's needs enough time to balance the refrigerant gas inside its circuits. If a power shortage occurs and recovers in a short time, it will cause damage to your connected appliances. To prevent this kind of damage, please check with the manufacturer of air conditioner to see if it's equipped with time-delay function before installation. Otherwise, this inverter/charger will trigger an overload fault and cut off the output to protect your appliance, but sometimes it may still cause internal damage to the air conditioner.

## 10. Rapid Shutdown (RSD)

This Inverter built-in a Rapid Shutdown transmitter device. While emergency or abnormal condition detected, the inverter will cut off the RSD power supply and stop AC output. At the same time, PV conductor voltage will be reduced to 30V within 30 seconds. The Rapid Shutdown transmitter needs to be matched with AP SMART's RSD product, detail information please refer to the instructions from AP SMART.

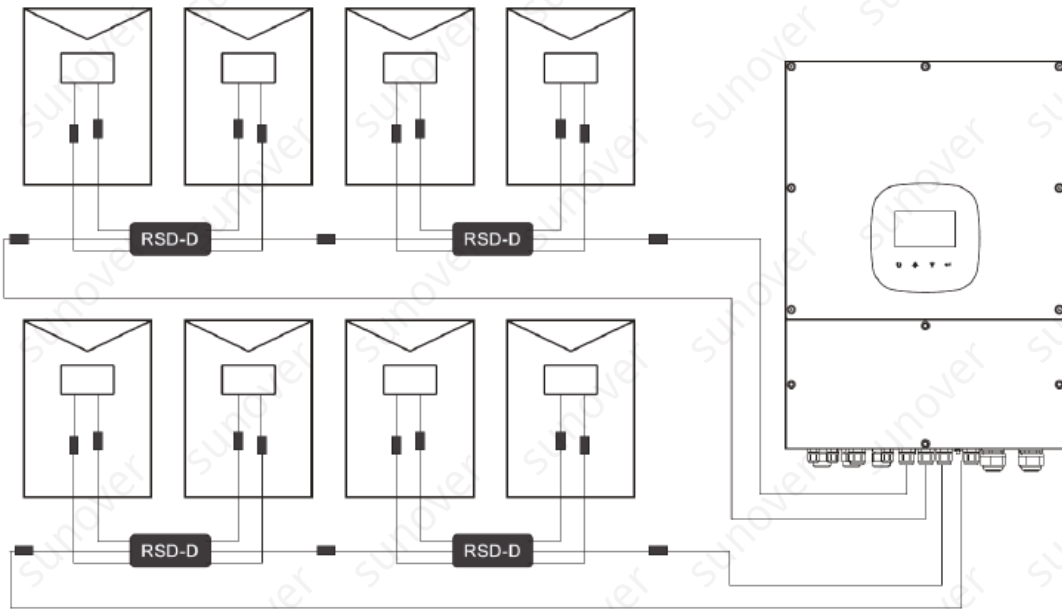

The system can also utilize an External E-Stop Switch if your AHJ deems it necessary. If trying to utilize the external E-Stop switch, the external switch must have normally closed contact type for emergency shutdown.

## External E-Stop Wiring Installation

1. Begin by removing the short bar from between the terminals.

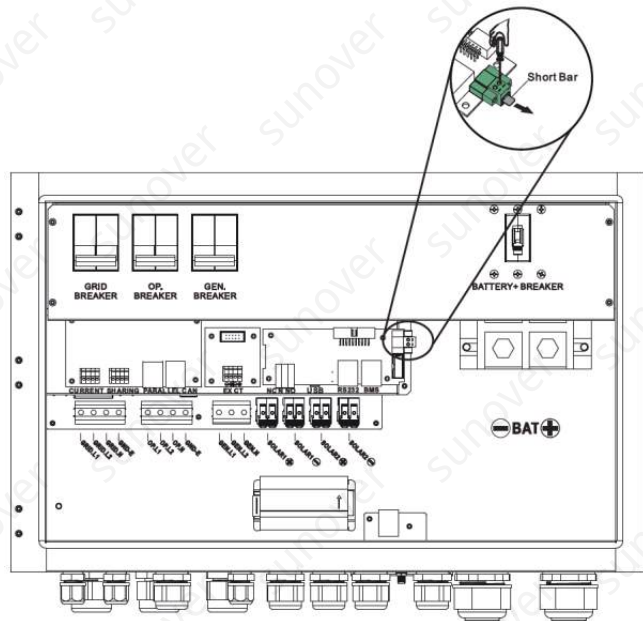

2. Wire the E-Stop Switch into the terminals according to the Switch's specifications.

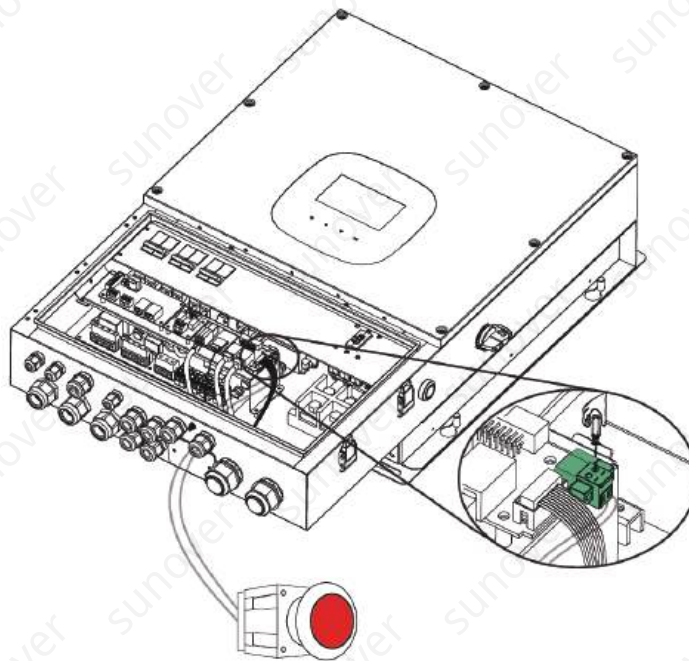

In case of emergency, press the rapid shutdown button to cut off the RSD power supply, followed by cutting the inverter AC Output along with it.

## 11. Communication

The inverter is equipped with several communication ports to communicate with a PC with the corresponding software. Follow the below procedure to connect the communication wiring and install the software.

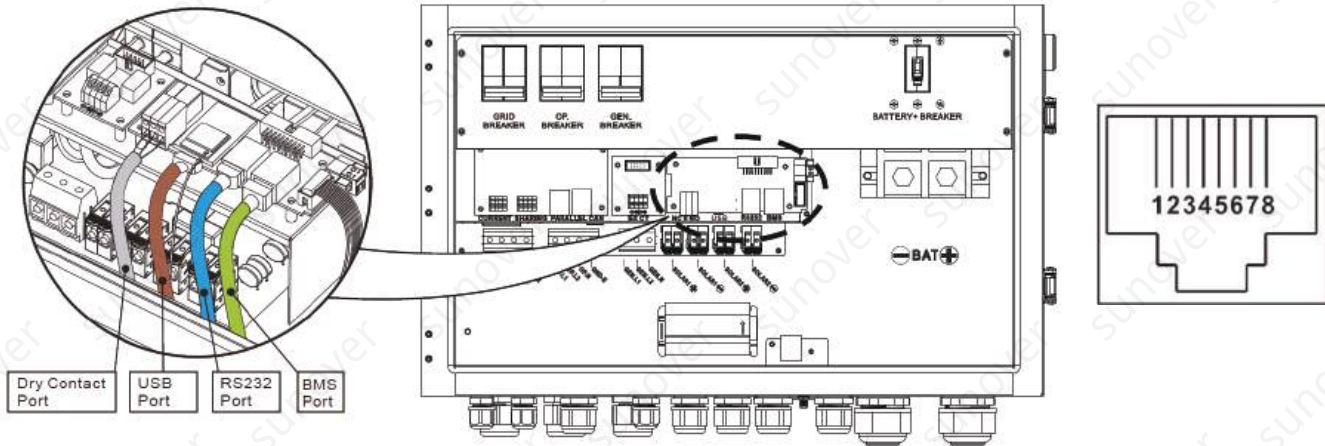

Please install monitoring software in your computer. Detailed information is listed in the next chapter. After software is installed, you may initial the monitoring software and extract data through communication port.

### 11-1. Wi-Fi Connection

This unit is equipped with a Wi-Fi transmitter. The Wi-Fi transmitter can enable wireless communication between the off-grid inverters and the monitoring platform. Users can access and control the monitored inverter with downloaded APP. You may find "i.Solar" app from the Apple® Store and Google® Play Store. All data loggers and parameters are saved in iCloud. For quick installation and operation, please refer to The Wi-Fi Operation Guide for details.







### 11-2. Pin Assignment for RS-232 Communication Port

PIN #	Definition	PIN #	Definition
PIN 1	RS232TX	PIN 5	NC
PIN 2	RS232RX	PIN 6	NC
PIN 3	NC	PIN 7	NC
PIN 4	NC	PIN 8	GND

### 11-3. Pin Assignment for BMS Communication Port

PIN #	Definition	PIN #	Definition
PIN 1	RS232TX	PIN 5	RS485A
PIN 2	RS232RX	PIN 6	CANH
PIN 3	RS485B	PIN 7	CANL
PIN 4	NC	PIN 8	GND

## 11-4. Warning Codes

Code	Warning Event	Icon (flashing)	Description
60	Charge and discharge prohibited		If battery status is not allowed to charge and discharge after the communication between the inverter and battery is successful, it will show code 60 to stop charging and discharging battery.
61	Communication lost between inverter and BMS		Communication lost (only available when the battery type is setting as "Pylontech Battery", "WECO Battery" or "Soltaro Battery".) <ul style="list-style-type: none"> <li>After battery is connected and communication signal is not detected for 3 minutes, buzzer will beep. After 10 minutes, inverter will stop charging and discharging to lithium battery.</li> <li>Communication lost occurs after the inverter and battery is connected successfully, buzzer beeps immediately.</li> </ul>
62	Installed battery number is changed		Battery number is changed. It probably is because of communication lost between battery packs.
69	Charging is prohibited		If battery status is not allowed to charge after the communication between the inverter and battery is successful, it will show code 69 to stop charging battery.
70	Force charge		If battery status must to be charged after the communication between the inverter and battery is successful, it will show code 70 to charge battery.
71	Discharging is prohibited		If battery status is not allowed to discharge after the communication between the inverter and battery is successful, it will show code 71 to stop discharging battery.

## 11-5. Dry Contact Signal

There is one dry contact available on the bottom panel. It could be used to remote control external generator.



**CAUTION:** The application of the dry contact should not exceed the electric parameter shown as below. Otherwise, the internal relay will be damaged.

### Electric Parameter

Parameter	Symbol	Max.	Unit
Relay DC voltage	Vdc	30	V
Relay DC current	Idc	1	A

## Function Description

Unit Status	Condition	Dry contact port: 	
		NO&C	NC&C
Power Off	Unit is off and no output is powered.	Open	Close
Power On	Battery voltage is lower than the set battery cut-off discharging voltage when grid is available.	Close	Open
	Battery voltage is lower than set battery cut-off discharging voltage when grid is unavailable.	Close	Open
	Battery voltage is higher than the 2 setting values: 1. Battery re-discharging voltage when grid is available. 2. Battery re-discharging voltage when grid unavailable.	Open	Close

You can set the related parameters in software. Refer to below chart:

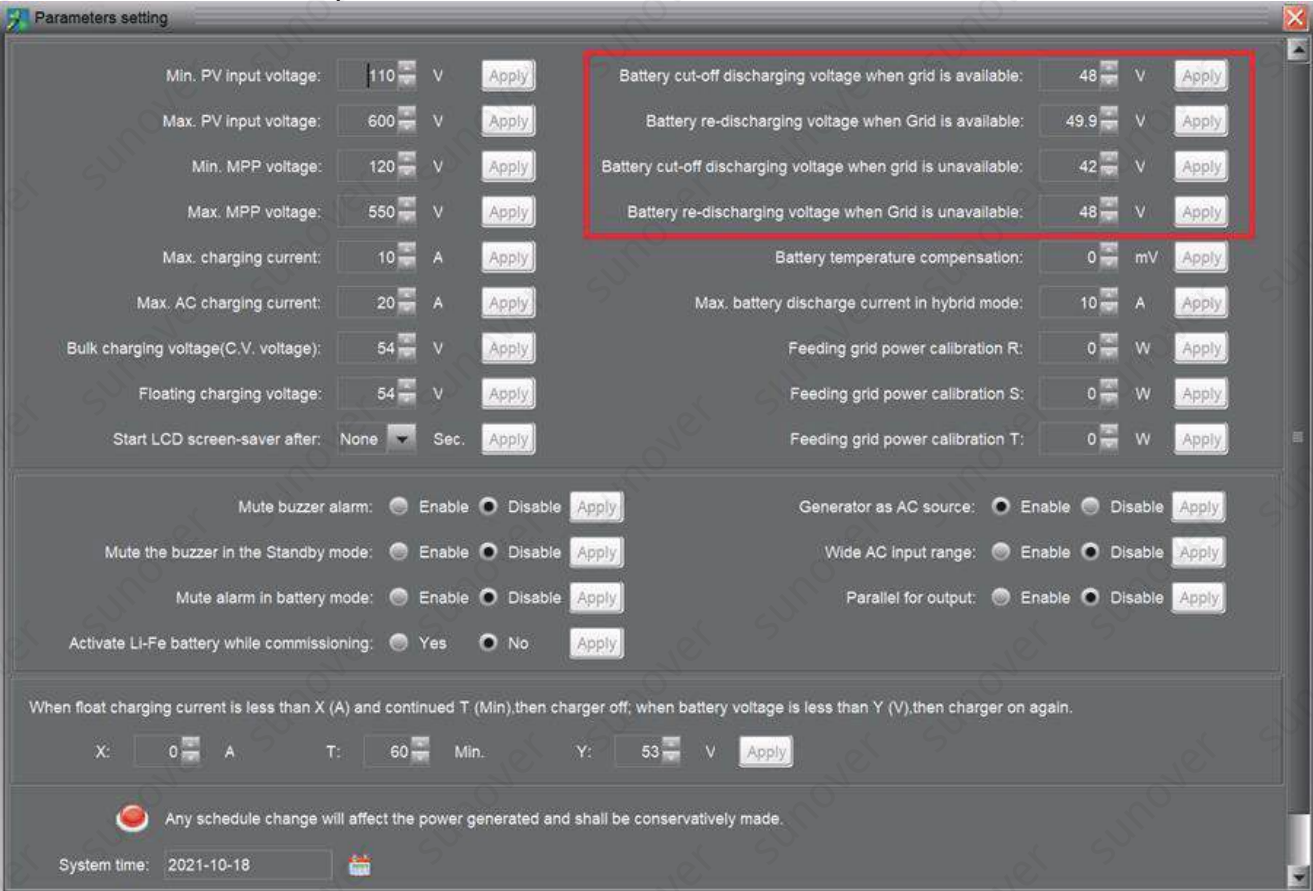

The screenshot shows the 'Parameters setting' window with the following parameters:

- Min. PV input voltage: 110 V
- Max. PV Input voltage: 600 V
- Min. MPP voltage: 120 V
- Max. MPP voltage: 550 V
- Max. charging current: 10 A
- Max. AC charging current: 20 A
- Bulk charging voltage(C.V. voltage): 54 V
- Floating charging voltage: 54 V
- Start LCD screen-saver after: None Sec.
- Battery cut-off discharging voltage when grid is available: 48 V
- Battery re-discharging voltage when Grid is available: 49.9 V
- Battery cut-off discharging voltage when grid is unavailable: 42 V
- Battery re-discharging voltage when Grid is unavailable: 48 V
- Battery temperature compensation: 0 mV
- Max. battery discharge current in hybrid mode: 10 A
- Feeding grid power calibration R: 0 W
- Feeding grid power calibration S: 0 W
- Feeding grid power calibration T: 0 W
- Mute buzzer alarm: Enable/Disable
- Mute the buzzer in the Standby mode: Enable/Disable
- Mute alarm in battery mode: Enable/Disable
- Activate LI-Fe battery while commissioning: Yes/No
- Generator as AC source: Enable/Disable
- Wide AC input range: Enable/Disable
- Parallel for output: Enable/Disable
- When float charging current is less than X (A) and continued T (Min), then charger off, when battery voltage is less than Y (V), then charger on again.
  - X: 0 A
  - T: 60 Min.
  - Y: 53 V

System time: 2021-10-18

## 12. Commissioning

1. Check the following requirements before commissioning:
  - Ensure that the inverter is firmly secured
  - Check if the open circuit DC voltage of the PV module meets the requirements (see Section 6)
  - Check if the open circuit utility voltage of the utility is approximately the same as the nominal expected value from local utility company.
  - Check if the connection of AC cable to grid (utility) is correct, if the utility is required.
  - Full connection to PV modules.
  - AC circuit breaker (only applied when the utility is required), battery circuit breaker, and DC circuit breaker are installed correctly.
  
2. Switch on the battery circuit breaker and then switch on the PV DC breaker. After that, if there is utility connection, please switch on the AC circuit breaker. At this moment, the inverter is turned on already. However, there is no output generation for loads. Then:
  - If the LCD lights up to display the current inverter status, commissioning has been successful. After pressing "ON" button for 1 second when the utility is detected, the inverter will start to supply power to the loads. If no utility exists, simply press "ON" button for 3 seconds; then, this inverter will start to supply power to the loads.
  - If a warning/fault indicator appears in LCD, an error has occurred to this inverter. Please inform your installer.
  
3. Please insert CD into your computer and install monitoring software in your PC. Follow the below steps to install software.
  - Follow the on-screen instructions to install the software.
  - When your computer restarts, the monitoring software will appear as shortcut icon located in the system tray, near the clock.

## 13. Initial Setup

Before inverter operation, it's required to set up "Operation Mode" via software. Please strictly follow steps below to set up. For more details, please check the software manual.

1. After turning on the inverter and installing the software, please click "Open Monitor" to enter main screen of this software.
2. Log in into software first by entering default password "administrator".
3. Select Device Control>>MyPower Management. It is to set up inverter operation mode and personalized interface. Refer to diagram below.

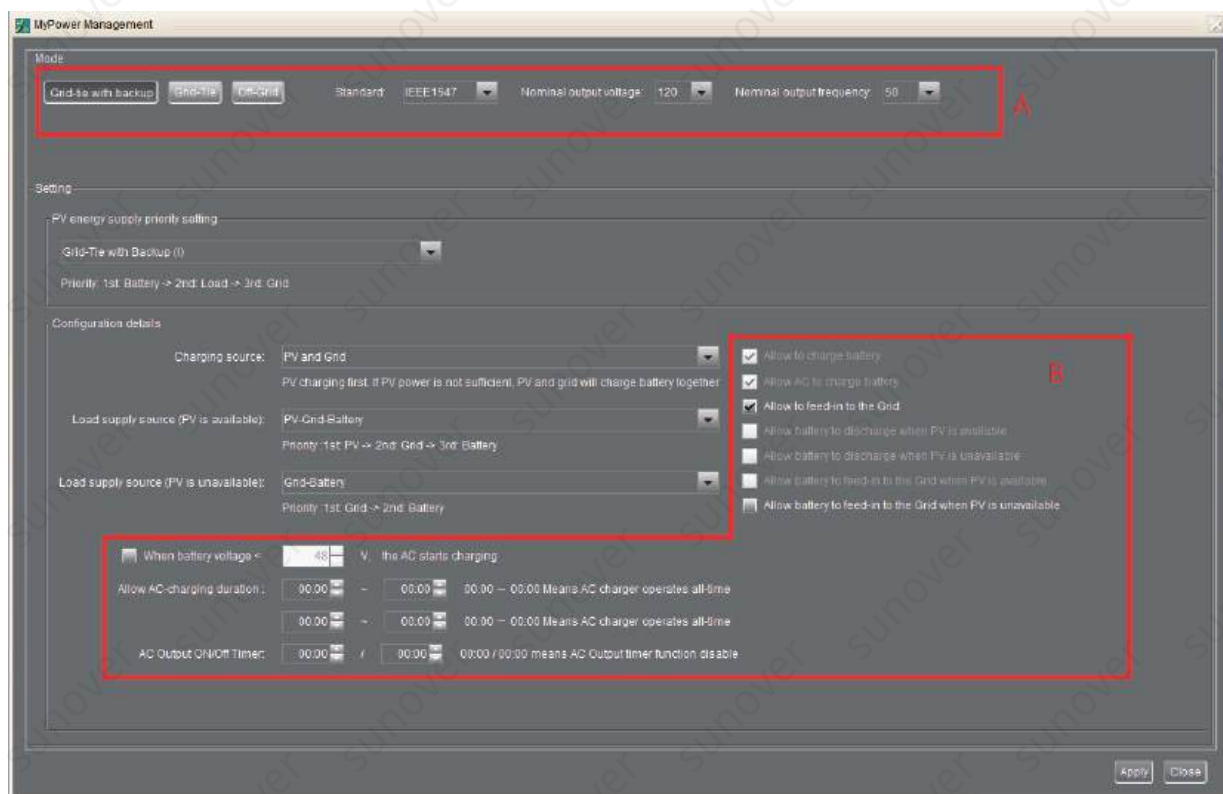

### 13-1. Setting

There are three operation modes:

Grid-tie with backup (I, II, III and IV)	PV power can feed-in back to grid, provide power to the load and charge the battery.
Grid-Tie	Only PV power can feed-in back to grid.
Off-Grid	PV power only provides power to the load and charge battery. No feed-in back to grid is allowed.

This section contents may be different based on different selected types of operations.

	LCD setting	Description
Mode	13	There are three operation modes: Grid-tie with backup (I, II, III and IV), Grid-Tie, and Off-Grid
Nominal Output Voltage	01	The factory default voltage is 120V. You can select 110V or 120V as required.

Nominal Output Frequency	02	The factory default frequency is 60hz. You can select 50Hz or 60Hz as required.
Allow AC charging duration	21-24	This is to set up a time period to allow AC (grid) to charge battery. When the duration is set up as 0:00-00:00, it means no time limit for AC to charge battery.
AC output ON/Off Timer	25, 26	Set up on/off time for AC output of inverter. If setting it as 00:00/00:00, this function is disabled.
Allow to charge battery	15	This option is automatically determined by setting in "Charging source". It's cannot be modified here. When "NONE" is selected in charging source section, this option becomes unchecked as grey text. When "Grid and PV" or "Grid or PV" is selected in charging source section, this option is selected by default. Under Grid-tie mode, this option is invalid.
Allow to feed-in to the Grid	16	This option is only valid under Grid-tie and Grid-tie with backup modes. Users can decide if this inverter can feed-in to the grid.
Allow battery to discharge when PV is available	-	This option is automatically determined by the setting in "Load supply source (PV is available)". When "Battery" is higher priority than "Grid" in Load supply source (PV is available), this option is default selected. Under Grid-tie, this option is invalid.
Allow battery to discharge when PV is unavailable	-	This option is automatically determined by setting in "Load supply source (PV is unavailable)". When "Battery" is higher priority than "Grid" in Load supply source (PV is unavailable), this option is default selected. Under Grid-tie mode, this option is invalid.
Allow battery to feed-in to the Grid when PV is available	17	This option is only valid in Grid-tie with backup II or Grid-tie with backup III modes.
Allow battery to feed-in to the Grid when PV is unavailable	16	This option is only valid in all options of Grid-tie with backup mode.
PV energy support priority setting	14	This will affect the selection of "Battery charging source (LCD setting 15)", "Load supply source (LCD setting 19 and 20)".



**CAUTION:** Wrong settings could the unit damage or the unit to not work.

**NOTE: Standard** (It can only be modified by software)

It will list local grid standard. It's requested to have factory password to make any modifications. Please check with your local dealer only when this standard change is requested.

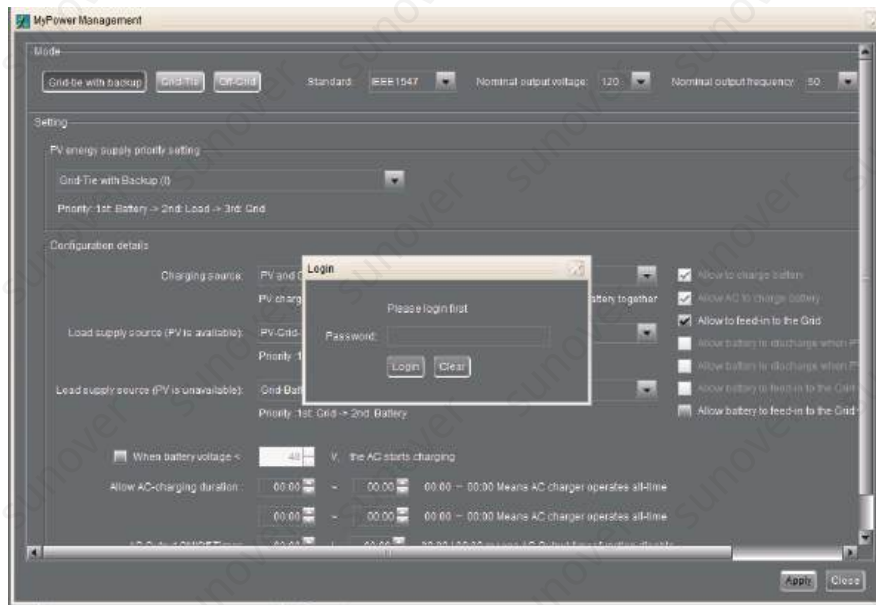

## 13-2. Grid-tie with Backup

PV power can feed-in back to grid, provide power to the load and charge the battery. There are four options available in this mode: Grid-tie with backup I, II, III and IV. In this mode, users can configure PV power supply priority, charging source priority and load supply source priority. However, when Grid-tie with backup IV option is selected in PV energy supply priority, the inverter is only operated between two working logics based on defined peak time and off-peak time of electricity. Only peak time and off-peak time of electricity are able to set up for optimized electricity usage.

Below are the options for Grid-tie with backup I, II, and III. The configuration for Grid-tie with backup IV can be seen in 14-2-4. Grid-tie with backup (IV).

### PV energy supply priority setting for each option:

Option	Priority Setting	Description
I	1 <sup>st</sup> Battery, 2 <sup>nd</sup> Load and 3 <sup>rd</sup> Grid	PV power will charge battery first, then provide power to the load. If there is any remaining power left, it will feed-in to the grid.
II	1 <sup>st</sup> Load, 2 <sup>nd</sup> Battery and 3 <sup>rd</sup> Grid	PV power will provide power to the load first. Then, it will charge the battery. If there is any remaining power left, it will feed-in to the grid.
III	1 <sup>st</sup> Load, 2 <sup>nd</sup> Grid and 3 <sup>rd</sup> Battery	PV power will provide power to the load first. If there is more PV power available, it will feed-in to the grid. If feed-in power reaches the max. feed-in power setting, the remaining power will charge battery. <b>NOTE:</b> The max. feed-in grid power setting is available in parameter setting. Please refer to software manual.

### Battery charging source:

<b>PV and Grid</b>	PV power charges battery first. If it is not sufficient, the grid will charge battery. <b>NOTE:</b> This is the default for grid-tie with backup I.
<b>PV only</b>	Only PV power is allowed to charge battery
<b>None</b>	PV Power and the grid will not charge the battery at all.

**Load supply source:** (see LCD setting 19 and 20)

When PV power is available	
<b>1<sup>st</sup> PV, 2<sup>nd</sup> Grid, 3<sup>rd</sup> Battery</b>	If the battery is not fully charged, PV power will charge the battery first. The remaining PV power will provide power to the load. If it's not sufficient, grid will provide power to the load. If grid is not available at the same time, the battery power will back up. <b>NOTE:</b> This is the default for grid-tie with backup I.
<b>1<sup>st</sup> PV, 2<sup>nd</sup> Battery, 3<sup>rd</sup> Grid</b>	PV power will provide power to the load first. If it's not sufficient, battery power will provide power to the load. When battery power is running out or not available, the grid will back up the load. <b>NOTE:</b> This option will become ineffective during AC charging time and the priority will automatically become 1 <sup>st</sup> PV, 2 <sup>nd</sup> Grid and 3 <sup>rd</sup> Battery to prevent battery damage.
When PV power is not available	
<b>1<sup>st</sup> Grid, 2<sup>nd</sup> Battery</b>	Grid will provide power to the load at first. If grid is not available, battery power will provide power backup.
<b>1<sup>st</sup> Battery, 2<sup>nd</sup> Grid</b>	Battery power will provide power to the load at first. If battery power is running out, the grid will back up the load. <b>NOTE:</b> This option will become ineffective during the AC charging time and the priority will automatically become 1 <sup>st</sup> Grid and 2 <sup>nd</sup> Battery to prevent battery damage.

### 13-2-1. Grid-tie with backup (I)

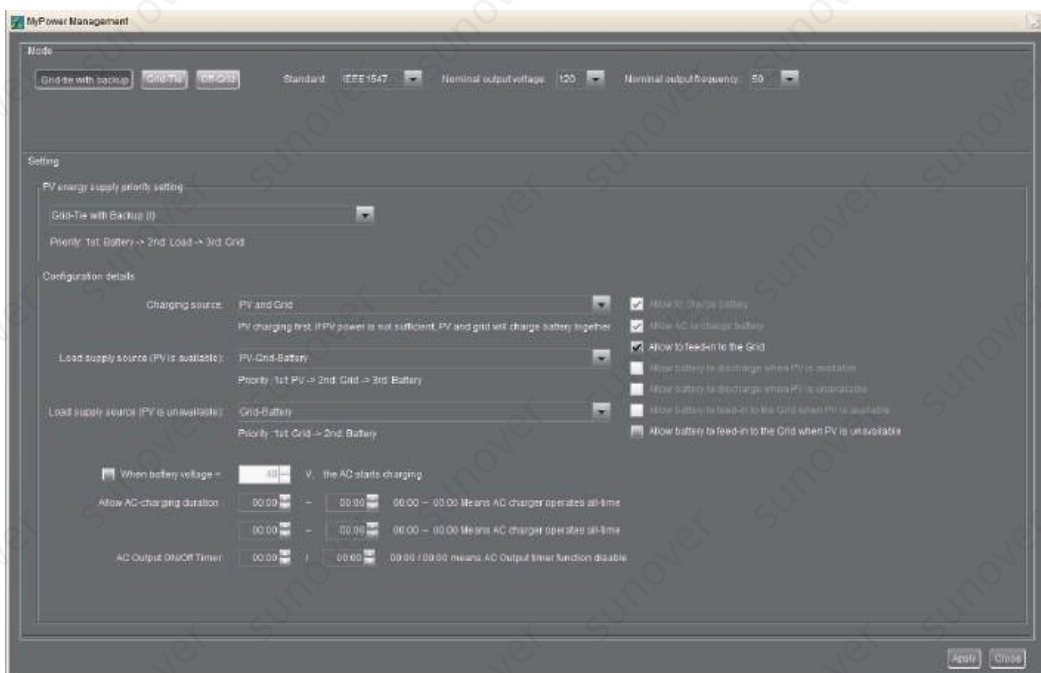

### 13-2-2. Grid-tie with backup (II)

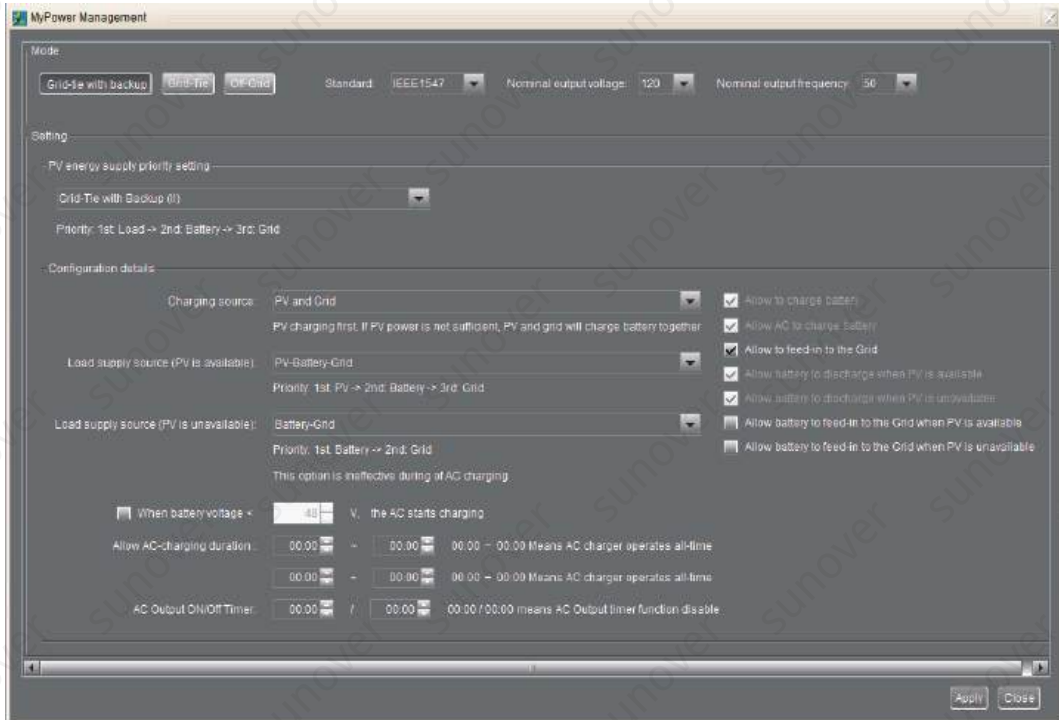

### 13-2-3. Grid-tie with backup (III)

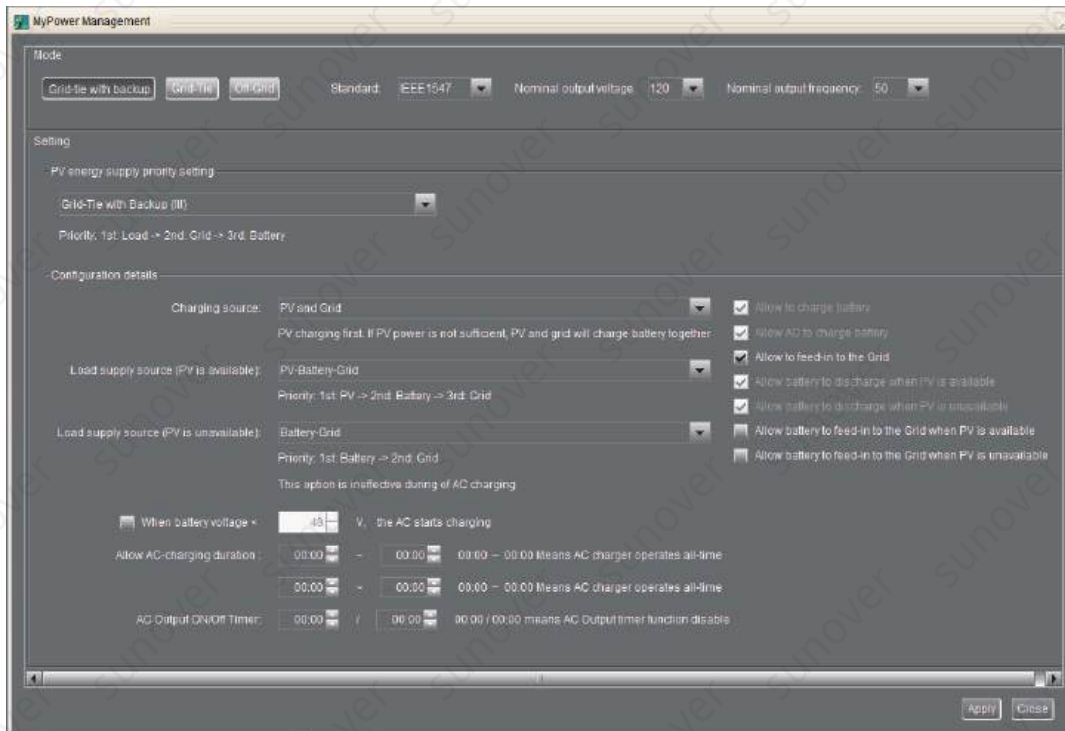

### 13-2-4. Grid-tie with backup (IV)

**NOTE:** Users are only allowed to set up peak time and off-peak electricity demand.

## Working logic under peak time

PV energy supply priority	1 <sup>st</sup> Load, 2 <sup>nd</sup> Battery and 3 <sup>rd</sup> Grid	PV power will provide power to the load first. If PV power is sufficient, it will charge battery next. If there is remaining PV power left, it will feed-in to the grid. Feed-in to the grid is by default disabled.
Battery charging source	PV only	Only after PV power fully supports the load, the remaining PV power is allowed to charge battery during peak time.
Load supply source	1 <sup>st</sup> PV, 2 <sup>nd</sup> Battery, 3 <sup>rd</sup> Grid	PV power will provide power to the load first. If PV power is not sufficient, battery power will back up the load. If battery power is not available, grid will provide the load. When PV power is not available, the battery power will supply the load first. If battery power is running out, grid will back up the load.

## Working logic under off-peak time

PV energy supply priority	1 <sup>st</sup> Battery, 2 <sup>nd</sup> Load and 3 <sup>rd</sup> Grid	PV power will charge battery first. If PV power is sufficient, it will provide power to the loads. The remaining PV power will feed to the grid. <b>NOTE:</b> The max. feed-in grid power setting is available in parameter setting. Please refer to software manual.
Battery charging source	PV and grid charge battery	PV power will charge battery first during off-peak time. If it's not sufficient, grid will charge battery.
Load supply source	1 <sup>st</sup> PV, 2 <sup>nd</sup> Grid, 3 <sup>rd</sup> Battery	When battery is fully charged, remaining PV power will provide power to the load first. If PV power is not sufficient, the grid will back up the load. If grid power is not available, battery power will provide power to the load.

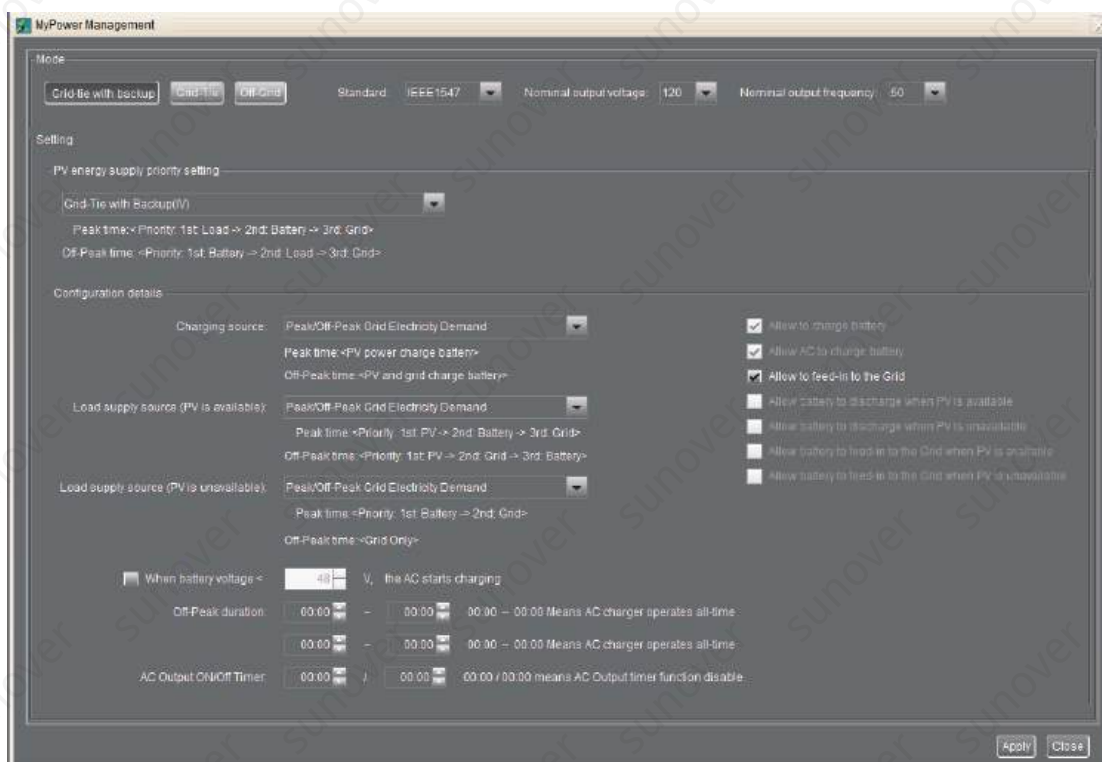

### 13-3. Grid-Tie

Under this operation mode, PV power only feeds-in to the grid. No priority setting is available.

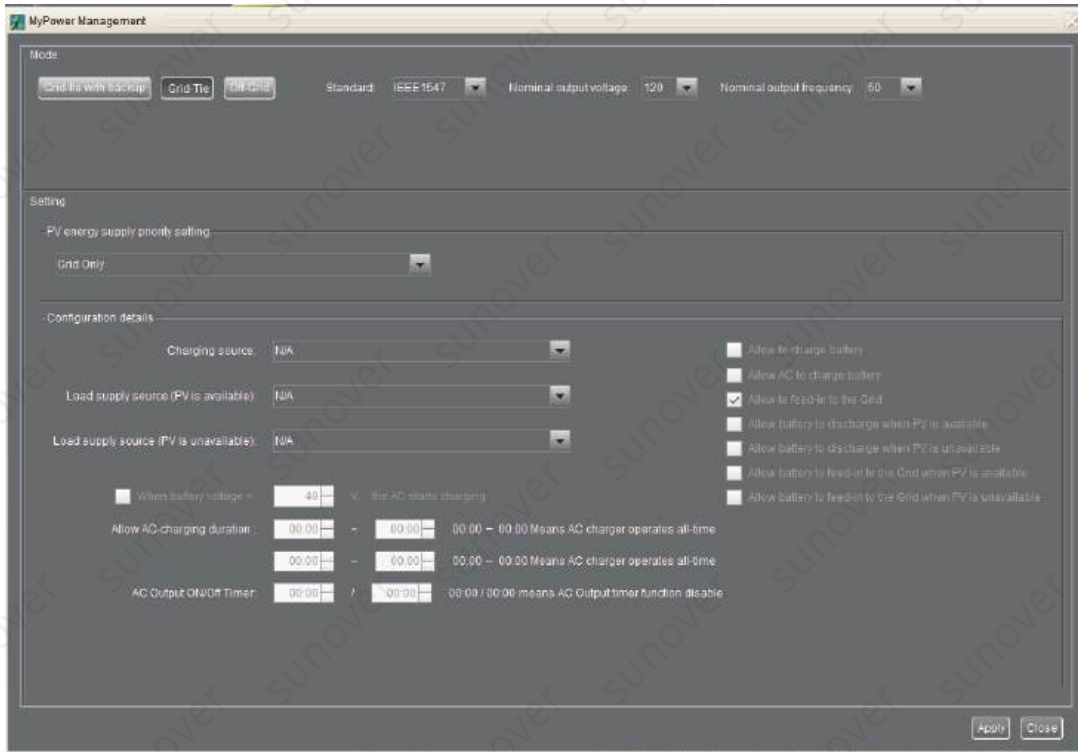

### 13-4. Off-Grid

#### PV energy supply priority setting:

Option	Priority Setting	Description
I	1 <sup>st</sup> Load, 2 <sup>nd</sup> Battery	<p>PV power will provide power to the load first and then charge the battery. Feed-in to the grid is not allowed under this mode.</p> <p>At the same time, the grid relay is connected in the Inverter mode, which means the transfer time from inverter mode to battery mode will be less than 15ms. There is no overload fault because the grid can supply load when connected load is over rated output capacity of the inverter.</p>
II	1 <sup>st</sup> Battery, 2 <sup>nd</sup> Load	<p>PV power will charge battery first. After the battery is fully charged, if there is remaining PV power left, it will provide power to the load. Feed-in to the grid is not allowed under this mode.</p> <p>At the same time, the grid relay is connected in the Inverter mode, which means the transfer time from inverter mode to battery mode will be less than 15ms. There is no overload fault because the grid can supply load when connected load is over rated output capacity of the inverter.</p>

III	1 <sup>st</sup> Load, 2 <sup>nd</sup> Battery	<p>PV power will provide power to load first and then charge battery. Feed-in to the grid is not allowed under this mode.</p> <p>The grid relay is NOT connected in the Inverter mode, which means that the transfer time from inverter mode to battery mode will be about 15ms. If the connected load is over the rated output capacity of the inverter and the grid is available, this inverter will allow the grid to provide power to the loads and PV power to charge battery. Otherwise, the inverter will activate fault protection.</p>
-----	---	---

**Battery charging source:**

<b>PV and Grid</b>	<p>If there is remaining PV power after supporting the loads, it will charge battery first. Only when PV power is not available, the grid will charge battery.</p> <p>NOTE: This is the default for off-grid I.</p>
<b>PV only</b>	Only PV power is allowed to charge battery
<b>None</b>	PV Power and the grid will not charge the battery at all.

**Load supply source:**

<b>When PV power is available</b>	
<b>1<sup>st</sup> PV, 2<sup>nd</sup> Battery, 3<sup>rd</sup> Grid</b>	<p>PV power will provide power to the load first. If it's not sufficient, battery power will provide power to the load. When battery power is running out or not available, the grid will back up the load.</p> <p><b>NOTE:</b> This is the default for Off-grid I.</p>
<b>1<sup>st</sup> PV, 2<sup>nd</sup> Grid, 3<sup>rd</sup> Battery</b>	<p>PV power will provide power to the load first. If it's not sufficient, the grid will provide power to the load. If grid is not available at the same time, battery power will back up.</p>
<b>When PV power is not available</b>	
<b>1<sup>st</sup> Grid, 2<sup>nd</sup> Battery</b>	<p>The grid will provide power to the load at first. If the grid is not available, battery power will provide power backup.</p>
<b>1<sup>st</sup> Battery, 2<sup>nd</sup> Grid</b>	<p>Battery power will provide power to the load at first. If battery power is running out, the grid will back up the load.</p> <p><b>NOTE:</b> This option will become ineffective during AC charging time and the priority will automatically become 1<sup>st</sup> Grid and 2<sup>nd</sup> Battery order to prevent battery damage.</p> <p><b>NOTE:</b> This is the default for Off-grid I</p>

### 13-4-1. Off-Grid (I): Default setting for off-grid mode.

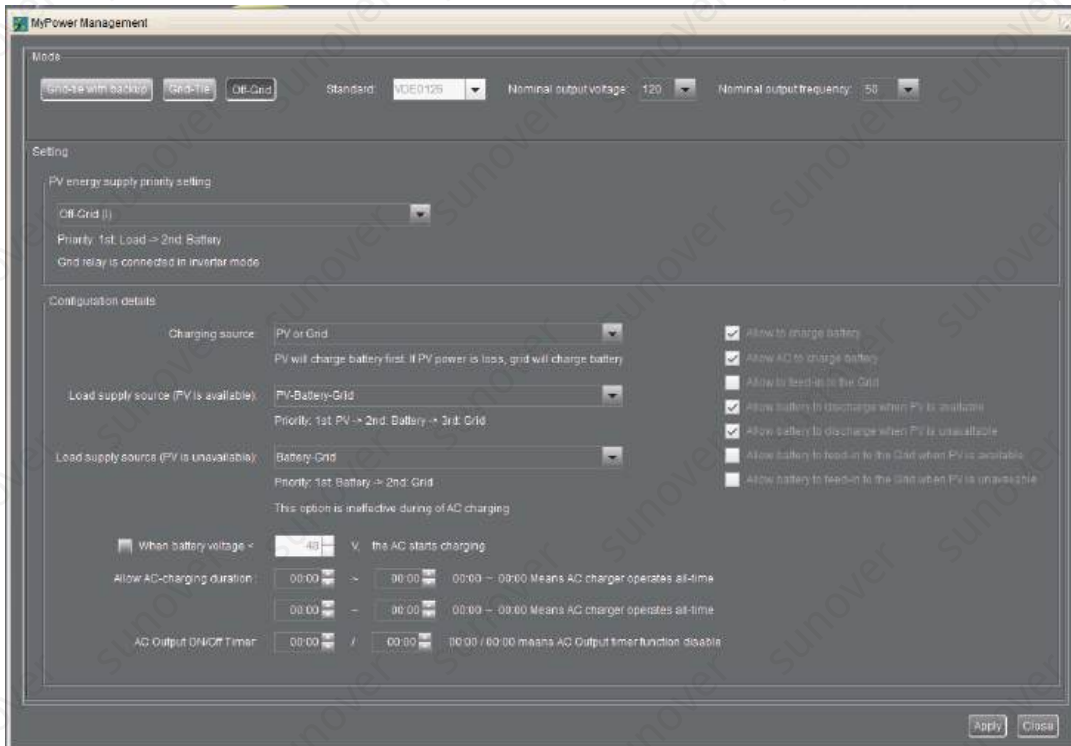

### 13-4-2. Off-Grid (II)

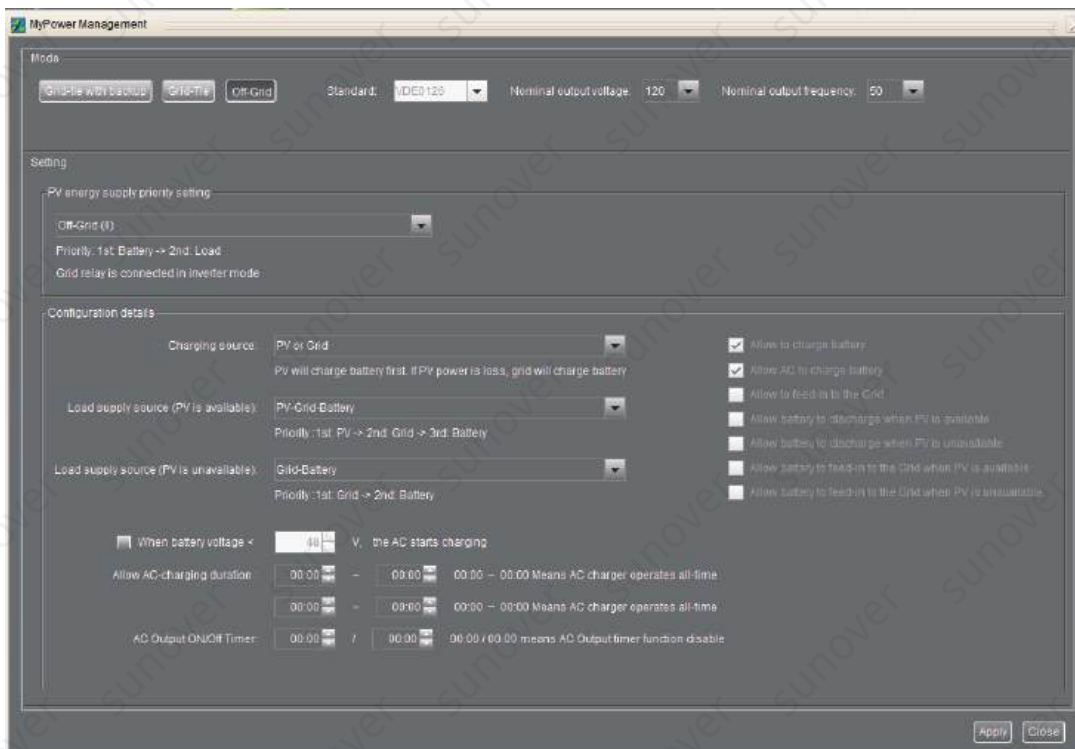

### 13-4-3. Off-Grid (III)

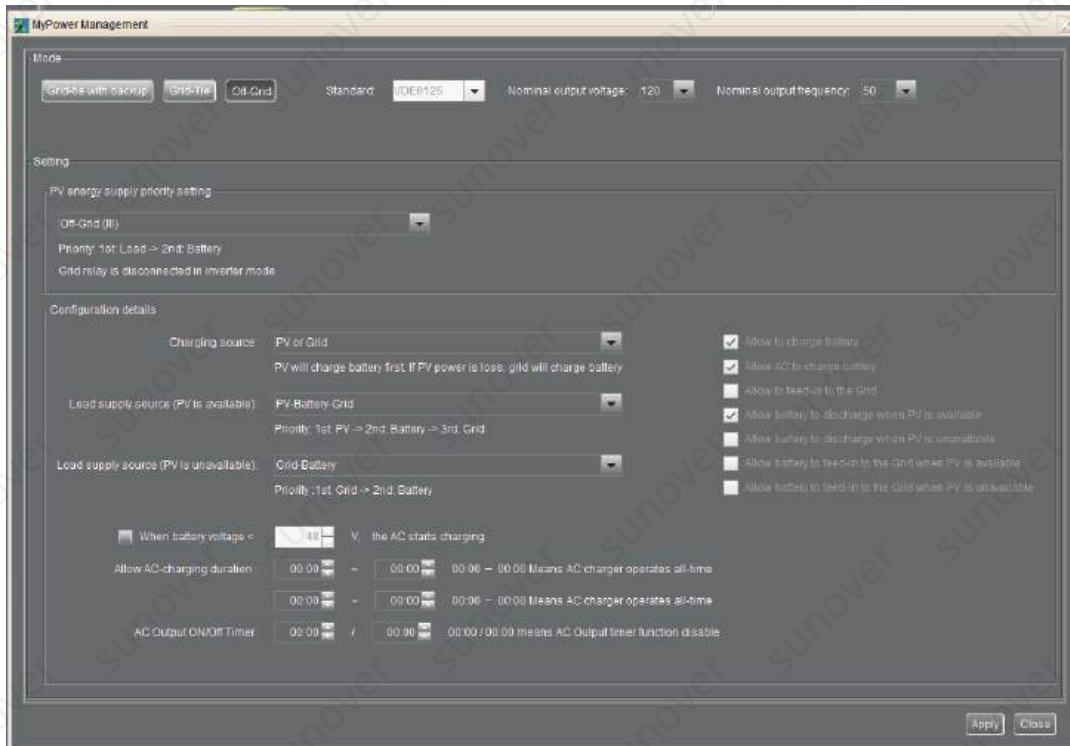

# 14. Operation

## 14-1. Interface

The operation LCD panel, shown in the chart below, includes four touchable function keys and a LCD display to indicate the operating status and input/output power information.

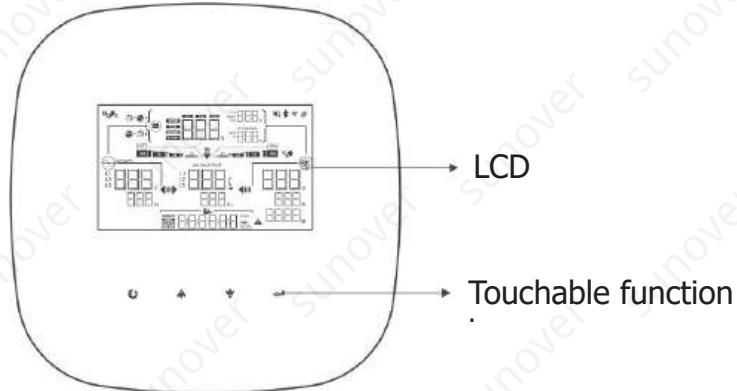





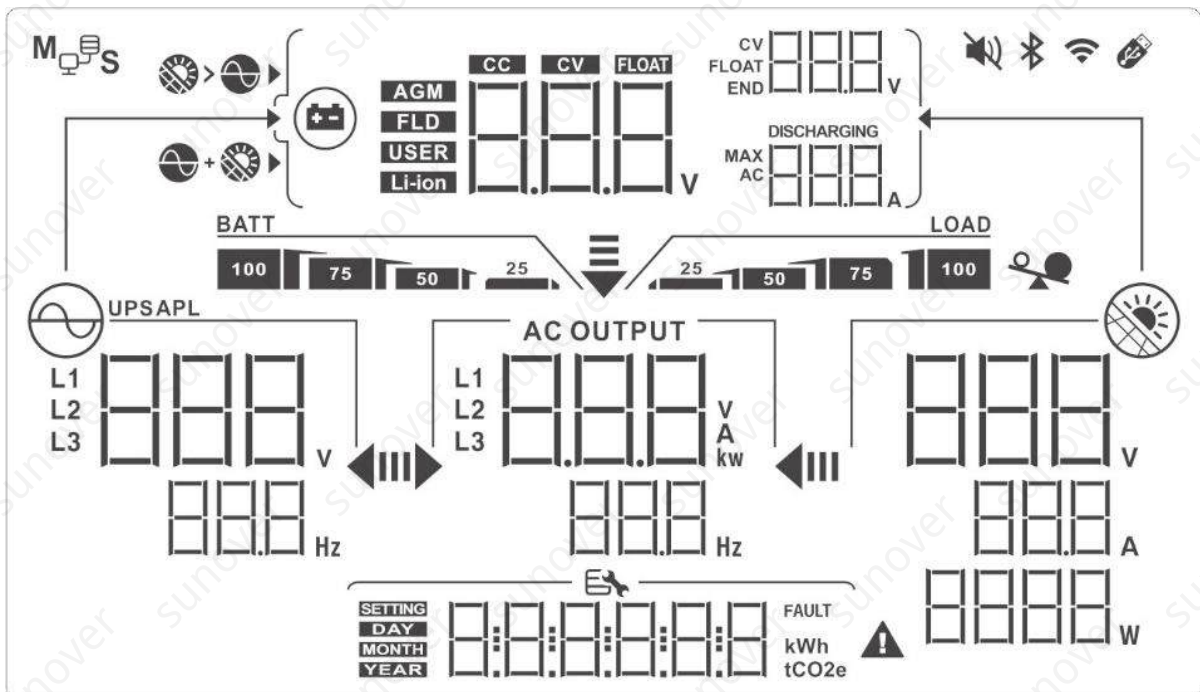



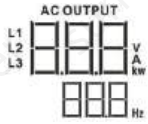
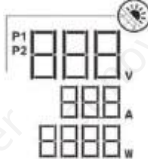







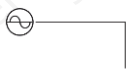

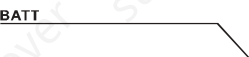
**NOTE:** To accurately monitor and calculate the energy generation, please calibrate the timer of this unit via software every one month. For the detailed calibration, please check the user manual of bundled software.

## 14-2. LCD Information



Display	Function
	Indicates AC input voltage and frequency. V: voltage, Hz: frequency, L1/L2/L3: Line phase

	<p>Indicates AC output power, voltage, frequency, or current.          kw: active power, V: voltage, Hz: frequency, A: current          L1/L2/L3: AC output phase</p>
	<p>Indicates PV input voltage, power or current.          V: voltage, W: power, P1: PV input 1, P2: PV input 2          A: current</p>
	<p>Allow AC and PV charging</p>
	<p>Only PV charging is allowed</p>
	<p>Indicates the battery voltage, the battery the current, charging status or the battery parameters          V: voltage, A: current, Li-ion: Lithium-ion battery type</p>
	<p>Indicates the battery level in battery mode.</p>
	<p>Indicates the warning and fault codes.</p>
	<p>Indicates the date and time or the date and time users set for querying energy generation.</p>
	<p>Indicates solar panels.          Icon flashing indicates PV input voltage is out of range.</p>
	<p>Indicates utility.          Icon flashing indicates utility voltage or frequency is out of range.</p>
	<p>Indicates battery condition. And the lattice of the icon indicates battery capacity.</p>
	<p>Icon  flashing indicates battery is not allowed to discharge.</p>
	<p>Icon  flashing indicates the battery voltage is too low.</p>
	<p>Indicates AC output for loads is enabled and inverter is providing power to the connected loads.</p>
	<p>This icon lighting indicates SW button is on and AC output is turned on.          This icon flashing indicates SW button is off but there is AC output.  <b>NOTE:</b> Be aware of this icon status. If the SW button is off with this icon flashing, the inverter will not provide backup power to AC output when an AC power failure occurs at the same time.</p>
	<p>Indicates overload.</p>
	<p>Indicates that parallel operation is working.</p>

### 14-3. Touchable function keys

Function Key	Operation	Function
↵	Enter	Quick touch. To confirm/enter the selection in setting mode
↶	ESC	Quick touch. Exit the setting.
⬆	Up	Quick touch. Select last selection or increase value.
⬇	Down	Quick touch. If it's in query menu, press this button to jump to next selection or decrease value. Mute alarm in standby mode or battery mode.

**NOTE:** If backlight shuts off, you may activate it by touching any button.

### 14-4. SW ON/OFF Operation (located on the side of the inverter)

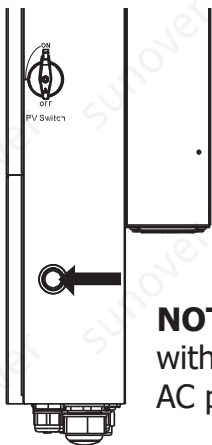

- Quick press to wake up inverter when the input power is supplied from battery only.
- Press and hold the button for 3 seconds to turn on/off the AC output of the inverter.











**NOTE:** Be careful to take notice of the "AC OUTPUT" icon status. If SW button is off with this icon flashing, the inverter will not provide backup power to AC output while AC power failure occurs at the same time.

### 14-5. LCD Setting



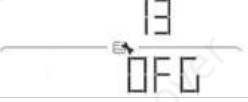



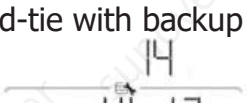

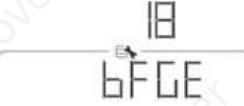

After touching and holding "Enter" button for 2 seconds, the unit will enter setting mode. Press "UP" or "DOWN" button to select setting programs. And then, press "ENTER" button to confirm the selection or ESC button to exit.

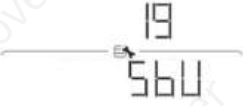
Program	Description	Selectable option
00	Exit setting mode	Escape 00 ESC
01	Output voltage	110Vac 01 110 120Vac(default) 01 120
02	Output frequency	50Hz 02 F50 60Hz(default) 02 F60

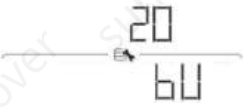
<b>03</b>	<b>Battery type</b>	User-Defined (default) 03 USE	If "User Defined" is selected, battery charge voltage and low DC cut off voltage can be set up in program 4, 7, 8 and 9.
		Pylontech battery 03 PYL	If selected, programs of 4, 7, 8 and 9 will be automatically set up. No need for further setting.
		WECO battery 03 WEC	If selected, programs of 4, 7, 8 and 9 will be auto-configured per battery supplier recommended. No need for further adjustment.
		Soltaro battery 03 SOL	If selected, programs of 4, 7, 8 and 9 will be automatically set up. No need for further setting.
		LIb-protocol compatible battery 03 LIB	Select "LIb" if using a Lithium battery compatible to the Lib protocol. If selected, programs of 4, 7, 8 and 9 will be automatically set up. No need for further setting.
		3 <sup>rd</sup> party Lithium battery 03 LIC	If selected, programs of 4, 7, 8 and 9 will be automatically set up. No need for further setting. Please contact the battery supplier for installation procedure.
		VSC 03 VSC	If selected, standard CAN protocol will be supported.
<b>04</b>	Maximum charging current: To configure total charging current for solar and utility chargers. (Max. charging current = utility charging current + solar charging current)	60A(default) 04 60	Setting range is 1A, then from 10A to 200A. The increment of each click is 10A.
<b>05</b>	Maximum utility charging current	60A(default) 05 UT 60	Setting range is from 10A to 200A. The increment of each click is 10A.
<b>06</b>	Maximum discharging current	200A(default) 06 200	Setting range is from 10A to 200A. The increment of each click is 10A.
<b>07</b>	Bulk charging voltage (C.V voltage)	Default setting: 56.0V 07 CV560	Setting range is from 48.0V to 60.0V. The increment of each click is 0.1V.

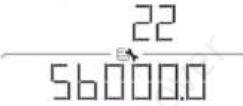
08	Floating charging voltage	Default setting: 54.0V 	Setting range is from 48.0V to 60.0V. The increment of each click is 0.1V.
09	Low DC cut off battery voltage setting when grid is unavailable	Default setting: 42.0 	Setting range is from 40V to 60V. The increment of each click is 0.1V.
10	Battery re-discharging voltage when grid is unavailable	Default setting: 48.0 	Setting range is form 40V to 60V. The increment of each click is 0.1V
11	Low DC cut off battery voltage when grid is available	Default setting: 48.0 	Setting range is from 42V to 60V voltage. The increment of each click is 0.1V
12	Battery re-discharging voltage when grid is available	Default setting: 54.0 	Setting range is from 42V to 60V voltage. Increment of each click is 0.1V
13	Operation Mode	Grid-tie with backup 	PV power can feed-in back to grid, provide power to the load and charge battery.
		Off-Grid 	PV power only provides power to the load and charge battery. No feed-in back to grid is allowed.
		Grid-Tie 	PV power only can feed-in back to grid.
14	PV energy supply priority setting	Grid-tie with backup Mode	
		Grid-tie with backup I 	Battery-Load-Grid: PV power will charge battery first, then provide power to the load. If there is any remaining power left, it will feed-in to the grid.
		Grid-tie with backup II 	Load-Battery-Grid: PV power will provide power to the load first. Then, it will charge battery. If there is any remaining power left, it will feed-in to the grid.
		Grid-tie with backup III 	Load-Grid-Battery: PV power will provide power to the load first. If there is more PV power available, it will feed-in to the grid. If feed-in power reaches the max. feed-in power setting, the remaining power will charge battery.

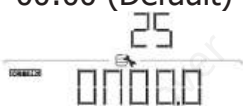
14	PV energy supply priority setting	Grid-tie with backup IV 14 Hbd4	If selected, it is only allowed to set up peak time and off-peak for electricity demand. Programs of 15, 17, 18, 19 and 20 can't be set and only programs of 21, 22, 23 and 24 can be set.
		Off-Grid Mode	
		Off-Grid I 14 OFG I	Load-Battery: PV power will provide power to the load first and then charge battery. Feed-in to the grid is not allowed under this mode. At the same time, the grid relay is connected.
		Off-Grid II 14 OFG2	Battery-Load: PV power will charge battery first. After battery is fully charged, if there is remaining PV power left, it will provide power to the load. Feed-in to the grid is not allowed under this mode. At the same time, the grid relay is connected.
		Off-Grid III 14 OFG3	Load-Battery: PV power will provide power to load first and then charge battery. Feed-in to the grid is not allowed under this mode. The grid relay is NOT connected.
		Grid-Tie Mode	
		14 NA	PV power only feeds-in to the grid. No priority setting is available.
15	Charger source priority	Solar and Utility(default) 15 SNU	If there is remaining PV power after supporting the loads, it will charge battery first. Only until PV power is not available, the grid will charge battery.
		Only Solar 15 OSO	It is only allow PV power to charge battery.
		None 15 NONE	It is not allowed to charge battery no matter it's PV power or grid.
16	Feed to grid function	Feed to grid disable (default) 16 GFd	Feed to grid enabled 16 GFE
17	Battery energy feed to grid function when PV energy is available	Battery feed to grid disable (default) 17 bFGd	Battery feed to grid enabled 17 bFGE

18	Battery energy feed to grid function when PV energy is unavailable.	Battery feed to grid disable (default) 	Feed to grid enabled 
19	Load supply source (PV is available)	SUB(default) 	Solar-grid-battery: PV power will provide power to the load first. If it's not sufficient, grid will provide power to the load. If grid is not available at the same time, battery power will back up.
		SBU 	Solar-Battery-Grid: PV power will provide power to the load first. If it's not sufficient, battery power will provide power to the load. When battery power is running out or not available, grid will back up the load.
20	Load supply source (PV is unavailable)	UB(default) 	Grid-Battery: Grid will provide power to the load at first. If grid is not available, battery power will provide power backup.
		BU 	Battery-Grid: Battery power will provide power to the load at first. If battery power is running out, grid will back up the load. This setting is ineffective during of AC charging.
21	Start charging time for first duration of AC charge	00:00 (Default) 	The setting range of start charging time for AC charger is from 00:00 to 23:00. The increment of each click is 1 hour.
22	Stop charging time for first duration of AC charge	00:00 (Default) 	The setting range of stop charging time for AC charger is from 00:00 to 23:00. The increment of each click is 1 hour.
23	Start charging time for second duration of AC charge	00:00 (Default) 	The setting range of start charging time for AC charger is from 00:00 to 23:00. The increment of each click is 1 hour.
24	Stop charging time for second duration of AC charge	00:00 (Default) 	The setting range of stop charging time for AC charger is from 00:00 to 23:00. The increment of each click is 1 hour.
25	Scheduled time for AC output on	00:00 (Default) 	The setting range of AC output on is from 00:00 to 23:00. The increment of each click is 1 hour.
26	Scheduled time for AC output off	00:00 (Default) 	The setting range of AC output off is from 00:00 to 23:00. The increment of each click is 1 hour.

27	LCD off waiting time	LCD is always on 27 LCD 0	The LCD turns off after 30s 27 LCD 30
		The LCD turns off after 60s(default) 27 LCD 60	The LCD turns off after 300s. 27 LCD 300
		The LCD turns off after 600s 27 LCD 600	
28	Alarm control	Alarm on(default) 28 b0N	Alarm off 28 b0F
29	Alarm control at standby mode	Alarm on in standby mode(default) 29 5Eb0N	Alarm off in standby mode 29 5Eb0F
30	Alarm control at battery mode	Alarm on in battery mode (default) 30 bEb0N	Alarm off in battery mode 30 bEb0F
31	Activate lithium battery when the device is powered on	Activate lithium battery disable(default) 31 bAd	Activate lithium battery enable 31 bAE
32	AC output mode	Single: This inverter is used in single phase application (default) 32 5IG	Parallel: This inverter is operated in parallel system. 32 PAL
33	Generator as AC source	Disabled (default) 33 dG d 15	Enabled 33 dG EN
34	Wide AC input range	Disabled (default) 34 uAC d 15	Enabled 34 uAC EN
36	External CT function (Refer to Appendix III for the details)	Disabled (default) 36 CTd	Enabled 36 CTE
37	PV parallel	Disabled(default) 37 PPd	Enabled 37 PPE

39	Generator port function (Refer to Appendix IV for the details)	Disabled (default) 39 ----- d 15	If selected, the input/output of generator port will be disabled.
		Enabled 39 ----- GEN	If selected, generator port will be activated. However, this port will not function in parallel mode.
40	Phase difference	180° phase difference (default) 40 ----- 180	120° phase difference 40 ----- 120
95	Time setting – Minute	95 ----- n1 n 00	For minute setting, the range is from 00 to 59.
96	Time setting – Hour	96 ----- HOU 00	For hour setting, the range is from 00 to 23.
97	Time setting– Day	97 ----- DAE 01	For day setting, the range is from 00 to 31.
98	Time setting– Month	98 ----- n0n 01	For month setting, the range is from 01 to 12.
99	Time setting – Year	99 ----- YEA 16	For year setting, the range is from 17 to 99.

#### 14-6. Query Menu Operation

The display shows the current contents that have been set. The displayed contents can be changed in the query menu via button operation. Press 'Enter' button to enter query menu. There are seven query selections:

- Input voltage or frequency of AC input.
- Frequency, voltage, power or load percentage of AC output.
- Input voltage or power of PV input.
- Battery voltage or capability percentage.

## Setting Display Procedure

Input voltage or frequency of AC input

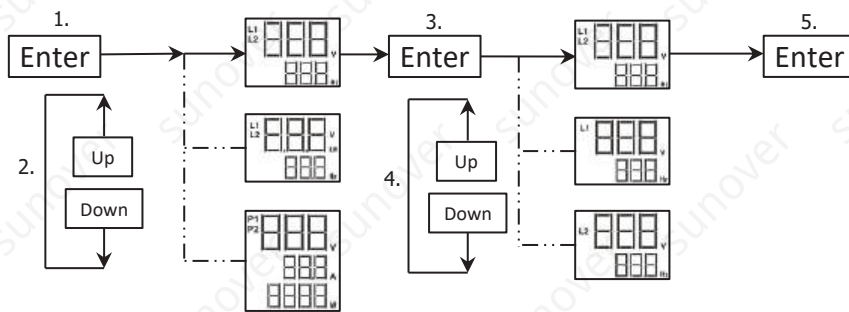

Frequency, voltage, power or percentage of AC output

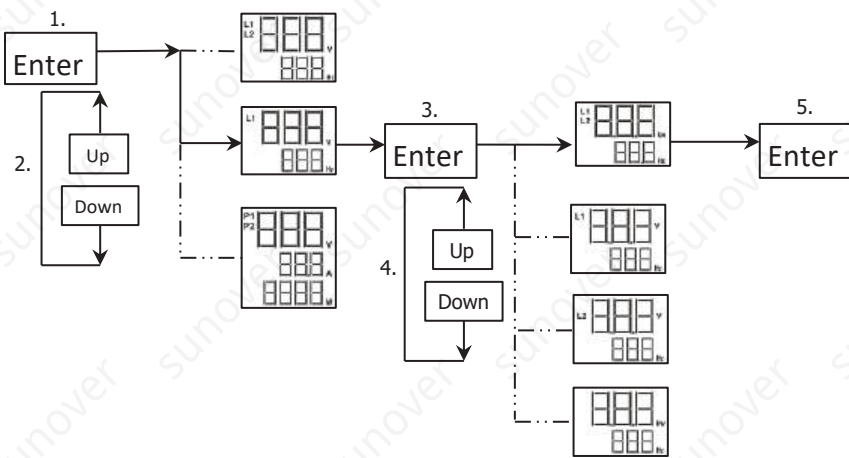

Input voltage or power of PV input.

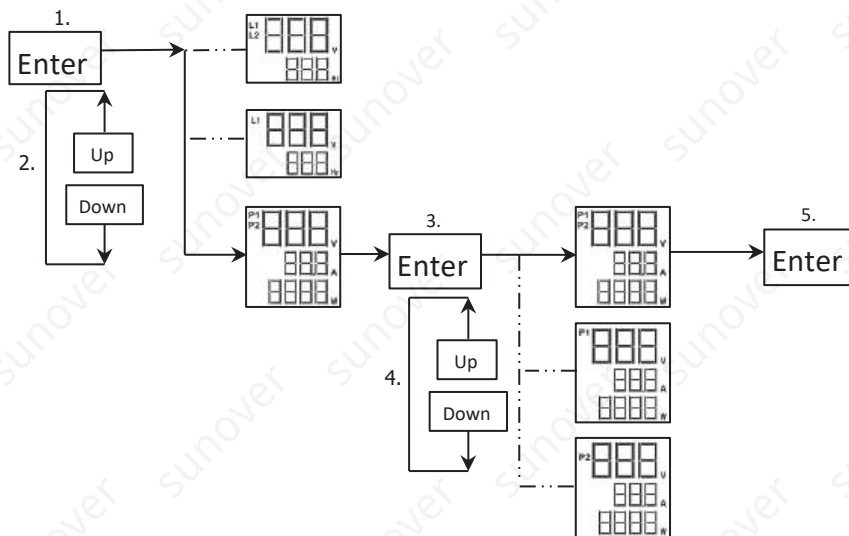

## Switch LCD Displayed Information

The LCD display information can be switched by pressing "▲" or "▼" key. The selectable information is switched as the following table in order.

Selectable information	LCD display
Real date	<p>Real date: 2020-08-18</p>
Real time	<p>Real time: 10:08</p>
PV energy generated today.	<p>PV energy generated this month = 8Wh.</p>
PV energy generated this month.	<p>PV energy generated this month = 8kWh.</p>

PV energy generated this year.

PV energy generated this year = 108kWh

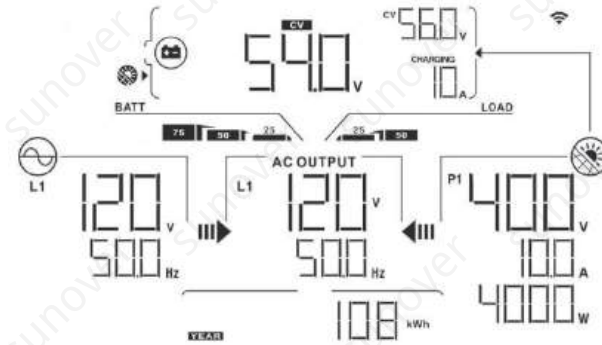

PV energy generated totally.

Total PV energy generation = 108kWh.

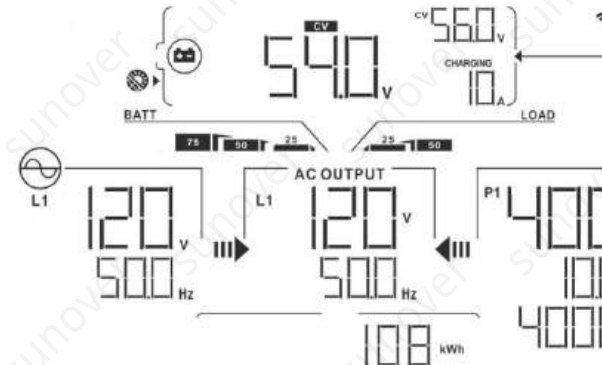

Main CPU version checking.

Main CPU version 01.01.

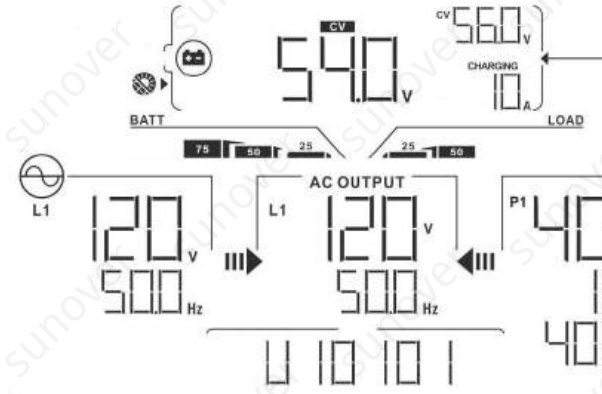

Secondary CPU version checking.

Secondary CPU version 01.01.



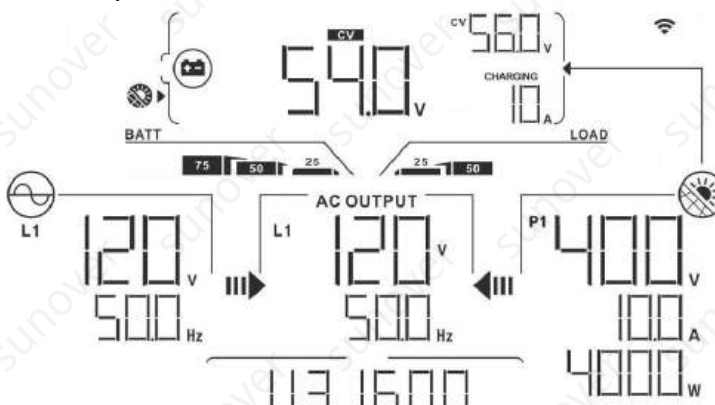
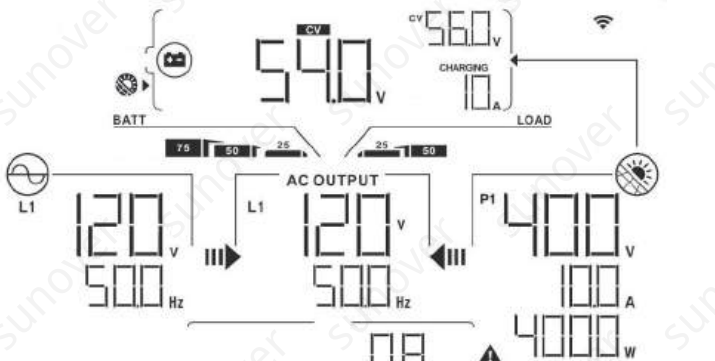

<p>Remote panel version checking</p>	<p>Remote panel version 16.00</p> 
<p>Warning code</p>	<p>Warning code: 08</p> 

### 14-7. Operation Mode & Display

Below is only contained LCD display for **grid-tie with backup mode (I)**. If you need to know the other operation modes with LCD display, please check with installer.

#### Inverter mode with grid connected

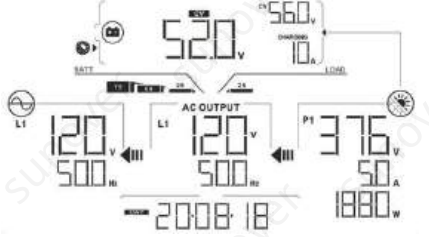
This inverter is connected to grid and working with DC/INV operation.

LCD Display	Description
	<p>PV power is sufficient to charge battery, provide power to loads, and feed in to the grid.</p>
	<p>PV power is sufficient to charge the battery first. However, remaining PV power is not sufficient to back up the load. Therefore, remaining PV power and the utility are supplying power to the connected load.</p>

	<p>PV power is generated, but not sufficient enough to charge battery by itself. PV power and the utility are charging battery at the same time. The utility is also supplying power to the connected load.</p>
	<p>PV power is sufficient to provide power to loads and feed power back to the grid.</p>
	<p>PV power and the utility are providing power to the connected loads because of insufficient PV power.</p>
	<p>Only the utility is charging battery and providing power to connected loads.</p>

**Inverter mode without grid connected**

This inverter is working with DC/INV operation and not connecting to the grid.

LCD Display	Description
	<p>PV power is sufficient to charge battery and provide power to the connected loads.</p>
	<p>PV power is generated, but not sufficient to power the loads by itself. PV power and battery are providing power to the connected loads at the same time.</p>
	<p>Only battery power is available to provide power to connected loads.</p>

	<p>Only PV power supplies power to connected loads.  <b>NOTE:</b> The inverter doesn't support battery hot pluggable. When the inverter is working with solar input, turn off the inverter first and then connect the battery.</p>
--	--

## Bypass mode

The inverter is working without DC/INV operation and connecting to the loads.

LCD Display	Description
	<p>Only utility is available to provide power to connected loads.</p>

## Standby mode

The inverter is working without DC/INV operation and load connected.

LCD Display	Description
	<p>This inverter is disabled on AC output or even if AC power output is enabled, but an error occurs on AC output, only PV power is sufficient to charge battery.</p>
	<p>If PV, battery or utility icons are flashing, it means they are not within acceptable working range. If they are not displayed, it means they are not detected.</p>

## 15. Charging Management

Charging Parameter	Default Value	Note
Charging current	60A	It can be adjusted via software from 5Amp to 200Amp.
Floating charging voltage (default)	54.0 Vdc	It can be adjusted via software from 50Vac to 62Vdc.
Max. absorption charging voltage (default)	56.0 Vdc	It can be adjusted via software from 50Vac to 62Vdc.
Battery overcharge protection	64.0 Vdc	
Charging process based on default setting.		
3 stages:		
1. max. charging voltage increases to 56V;		
2. charging voltage will maintain at 56V until charging current is down to 12 Amp;		
3. go to floating charging at 54V.		

This inverter can connect to the following battery types: sealed lead acid battery, vented battery, gel battery and lithium battery.

The detail installation and maintenance explanations of the external battery pack are provided in the manufacturer's external battery pack of manual.

If using sealed lead acid battery, please set up the max. charging current according to below formula:

$$\text{The maximum charging current} = \text{Battery capacity (Ah)} \times 0.2$$

For example, if you are using 300 Ah battery, then, maximum charging current is  $300 \times 0.2 = 60$  (A). Please use at least 50Ah battery because the settable minimum value of charging current is 10A. If using AGM/Gel or other types of battery, please consult with installer for the details.

Below is setting screen from the software:

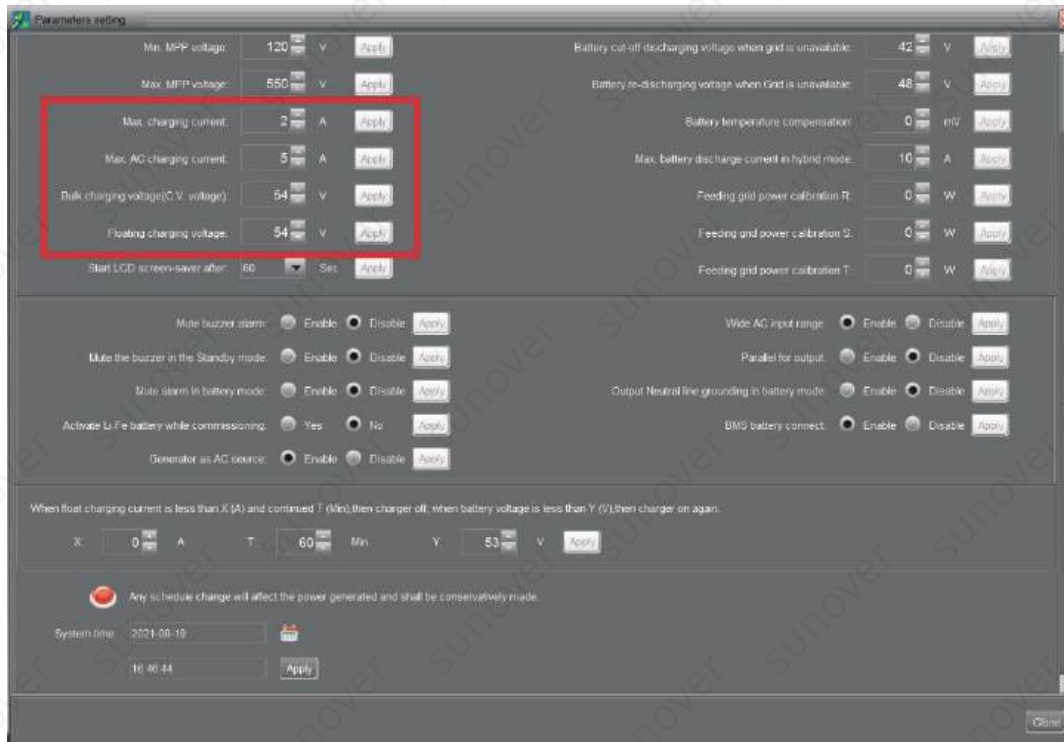

## 16. Maintenance & Cleaning

Check the following points to ensure proper operation of whole solar system at regular intervals.

- Ensure all connectors of this inverter are cleaned all the time.
- Before cleaning the solar panels, be sure to turn off PV DC breakers.
- Clean the solar panels, during the cool time of the day, whenever it is visibly dirty.
- Periodically inspect the system to make sure that all wires and supports are securely fastened in place.



**WARNING!** There are no user-replaceable parts inside of the inverter. Do not attempt to service the unit yourself.

### Battery Maintenance

- Servicing of batteries should be performed or supervised by personnel knowledgeable about batteries and the required precautions.
- When replacing batteries, replace with the same type and number of batteries or battery packs.
- The following precautions should be observed when working on batteries:
  - a) Remove watches, rings, or other metal objects.
  - b) Use tools with insulated handles.
  - c) Wear rubber gloves and boots.
  - d) Do not lay tools or metal parts on top of batteries.
  - e) Disconnect the charging source prior to connecting or disconnecting battery terminals.
  - f) Determine if battery is inadvertently grounded. If it is inadvertently grounded, remove source from ground. Contact with any part of a grounded battery can result in electrical shock. The likelihood of such shock can be reduced if such grounds are removed during installation and maintenance (applicable to equipment and remote battery supplies not having a grounded supply circuit).



#### **CAUTION:**

A battery can present a risk of electrical shock and high short-circuit current. Do not dispose of batteries in a fire. The batteries may explode.

Do not open or mutilate batteries. Released electrolyte is harmful to the skin and eyes. It may be toxic.



















## 17. Trouble Shooting

When there is no information displayed in the LCD, please check if PV module/battery/grid connection is correctly connected.

**NOTE:** The warning and fault information can be recorded by a remote monitoring software.

### 18-1. Warning List

There are 17 situations that are defined as warnings. When a warning situation occurs,  icon will flash. Touch "up" or "down" to select displaying warning code. If there are several codes, it will display in a sequence. Please contact your installer when you can't handle the warning situations.

Code	Warning Event	Icon (flashing)	Description
01	Line voltage high loss		Grid voltage is too high.
02	Line voltage low loss		Grid voltage is too low.
03	Line frequency high loss		Grid frequency is too high.
04	Line frequency low loss		Grid frequency is too low.
05	Line voltage loss for long time		Grid voltage is higher than 253V.
06	Ground Loss		Ground wire is not detected.
07	Island detect		Island operation is detected.
08	Line waveform loss		The waveform of grid is not suitable for inverter.
09	Line phase loss		The phase of grid is not in right sequence.
10	EPO detected		EPO is open.
11	Overload		Load exceeds rating value.
12	Over temperature		The temperature is too high inside.
13	Batter voltage low		Battery discharges to low alarm point.
14	Battery under-voltage when grid is loss		Battery discharges to shutdown point.
15	Battery open		Battery is unconnected or too low.
16	Battery under-voltage when grid is OK		Battery stops discharging when the grid is OK.
17	Solar over voltage		PV voltage is too high.
18	RSD is close		RSD is close
32	Communication lost between DSP and communication board		Communication lost between DSP and communication board

### 18-2. Fault Reference Codes

When a fault occurs, the icon  will flash as a reminder. See below for fault codes for reference.

Fault Code	Situation		Solution
	Fault Event	Possible Cause	
01	Bus voltage over	Surge	1. Restart the inverter. 2. If the error message still remains, please contact your installer.
02	BUS voltage under	PV or battery disconnect suddenly	1. Restart the inverter 2. If the error message still remains, please contact your installer.
03	BUS soft start time out	Internal components failed.	Please contact your installer.
04	INV soft start time out	Internal components failed.	Please contact your installer.
05	INV over current	Surge	1. Restart the inverter. 2. If the error message still remains, please contact your installer.
06	Over temperature	Internal temperature is too high.	1. Check the ambient temperature and fans. 2. If the error message still remains, please contact your installer.
07	Relay fault	Internal components failed.	Please contact your installer.
08	CT sensor fault	Internal components failed.	Please contact your installer.
09	Solar input power abnormal	1. Solar input driver damaged. 2. Solar input power is too much when voltage is more than 600V.	1. Please check if solar input voltage is higher than 600V. 2. Please contact your installer.
11	Solar over current	Surge	1. Restart the inverter. 2. If the error message still remains, please contact your installer.
12	GFCI fault	Leakage current exceeds the limit.	1. Check the wire and panels which may cause the leakage. 2. If the error message still remains, please contact your installer.
13	PV ISO fault	The resistance between PV and ground is too low.	
14	INV DC current over	Utility fluctuates.	1. Restart the inverter. 2. If the error message still remains, please contact your installer.
15	Arc fault detected	PV arc detected.	Please check PV module installation.
16	GFCI sensor fault	GFCI sensor failed.	Please contact your installer.
17	DSP and MCU Com. Loss	Communication loss between DSP and MCU	Please contact your installer.

<b>22</b>	Battery high voltage fault	Battery voltage exceeds the limit.	1. Check the battery voltage. 2. If the error message still remains, please contact your installer.
<b>23</b>	Over load	The inverter is loaded with more than 110% load and time is up.	Reduced the connected load by switching off some equipment.
<b>26</b>	INV short	Output short circuited.	Check if wiring is connected well and remove abnormal load.
<b>27</b>	Fan lock	Fan failed.	Please contact your installer.
<b>32</b>	DC/DC over current	Battery voltage fluctuates.	1. Restart the inverter. 2. If the error message still remains, please contact your installer.
<b>33</b>	INV voltage low	Internal components failed.	Please contact your installer.
<b>34</b>	INV voltage high	Internal components failed.	Please contact your installer.
<b>35</b>	Wire connection fault	Internal wires loosen.	Please contact your installer.
<b>36</b>	OP voltage fault	Grid connects to output terminal	Don't connect the grid to the output terminal.
<b>38</b>	Short circuited on PV input	Short circuited on PV input	Please contact your installer.
<b>47</b>	The L1/L2 of the inverter is short-circuited.	Output short circuited.	Check if all wiring is connected well and remove abnormal loads.
<b>60</b>	Current feedback into the inverter is detected.		1. Restart the inverter. 2. Check if L1/L2/N cables are not connected with wrong sequence in all inverters. 3. Make sure the sharing cables are connected in all inverters. 4. If the problem remains, please contact your installer.
<b>71</b>	The firmware version of each inverter is not the same.	Software differences do not support parallel.	1. Update all inverter firmware to the same version. 2. After updating, if the problem still remains, please contact your installer.
<b>72</b>	The output current of each inverter is different.		1. Check if sharing cables are connected well and restart the inverter. 2. If the problem remains, please contact your installer.
<b>80</b>	CAN data loss		1. Check if communication cables are connected well and restart the inverter. 2. If the problem remains, please contact your installer.
<b>81</b>	Host data loss		
<b>82</b>	Synchronization data loss		
<b>88</b>	BUS Balances overcurrent	Internal components failed.	Please contact your installer.
<b>89</b>	BUS balance hardware Fault	Internal components failed.	Please contact your installer.

## Appendix I: Parallel Installation Guide

### Introduction

This inverter can be used in parallel with maximum 6 units. The supported maximum output power is 60KW/60KVA.

### Parallel cable

You will find the following items in the package:



Parallel communication cable



Current sharing wires

### Overview

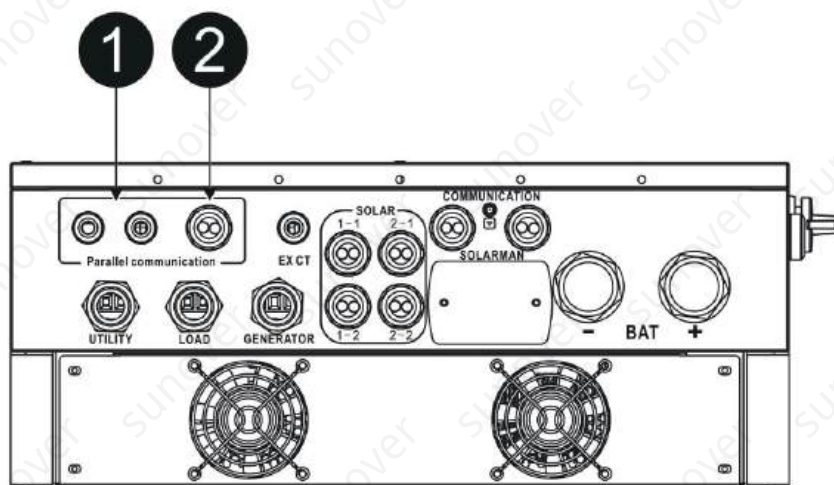

1. Current sharing port
2. Parallel communication port

### Mounting the Unit

When installing multiple units, please follow below chart.

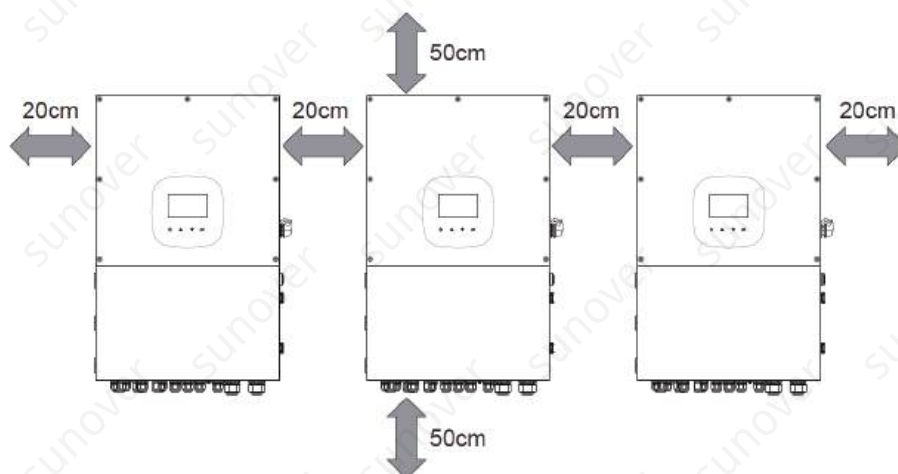

**NOTE:** For proper air circulation to dissipate heat, it's necessary to allow a clearance of approx. 20 cm to the side and approx. 50 cm above and below the unit. Be sure to install each unit in the same level.

## Wiring Connection

The cable size of each inverter is shown as below:

Recommended battery cable and terminal size for each inverter:

Wire Size	Ring Terminal			Torque value
	Cable mm <sup>2</sup>	Dimensions		
		D (mm)	L (mm)	
3/0AWG	85	8.4	56	7~12 Nm

Ring terminal:

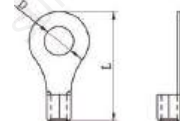

**WARNING!** Be sure the length of all battery cables is the same. Otherwise, there will be voltage difference between inverter and battery to cause parallel inverters to not work.

Recommended AC input and output cable size for each inverter:

AWG no.	Conductor cross-section	Torque
8-6 AWG	10~16 mm <sup>2</sup>	1.4~1.6Nm

You need to connect the cables of each inverter together. Take the battery cables for example. You need to use a connector or bus-bar as a joint to connect the battery cables together, and then connect to the battery terminal. The cable size used from joint to battery should be X times cable size in the tables above. "X" indicates the number of inverters connected in parallel. Regarding cable size of AC input and output, please also follow the same principle.



**CAUTION:** Please install a breaker at the battery side. This will ensure the inverter can be securely disconnected during maintenance and fully protected from overcurrent of battery.

**Recommended breaker specification of battery for each inverter:**

One unit*
250A/60VDC

\*If you want to use only one breaker at the battery side for the whole system, the rating of the breaker should be X times current of one unit. "X" indicates the number of inverters connected in parallel.

**Recommended battery capacity**

Inverter parallel numbers	2	3	4	5	6
Battery Capacity	400AH	600AH	800AH	1000AH	1200AH



**CAUTION:** Please follow the battery charging current and voltage from battery spec to choose the suitable battery. The wrong charging parameters will reduce the battery lifecycle sharply.

## Approximate back-up time table

Load (W)	Backup Time @ 48Vdc 400Ah (min)	Backup Time @ 48Vdc 600Ah (min)	Backup Time @ 48Vdc 800Ah (min)	Backup Time @ 48Vdc 1000Ah (min)	Backup Time @ 48Vdc 1200Ah (min)
20000	54	84	108	144	168
30000	36	54	72	96	108
40000	24	42	54	72	84
50000	21	33	45	54	66
60000	18	30	36	48	60

## PV Connection

Please refer to user manual of single unit for PV Connection.



**CAUTION:** Each inverter should connect to PV modules separately.

## Inverters Configuration

### Two inverters in parallel:

### Power Connection

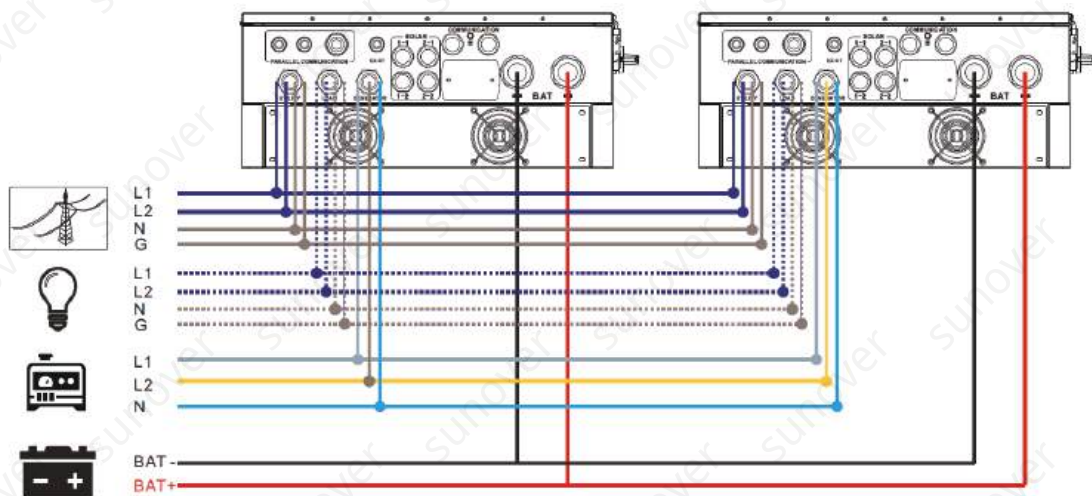

## Communication Connection

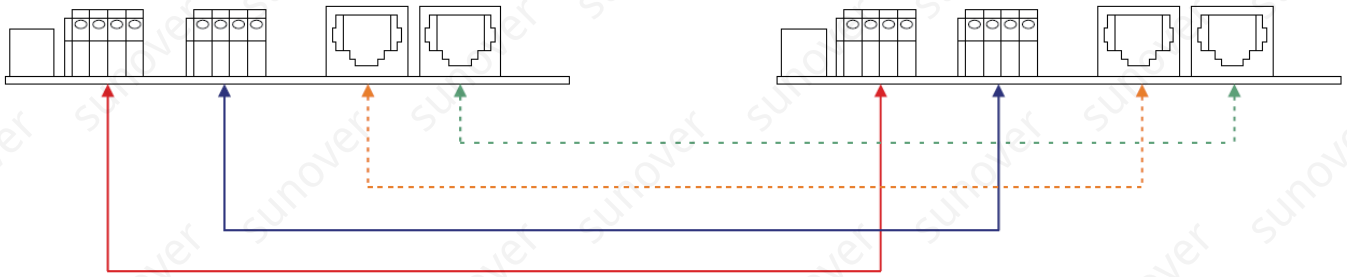

## Six inverters in parallel:

### Power Connection



### Communication Connection

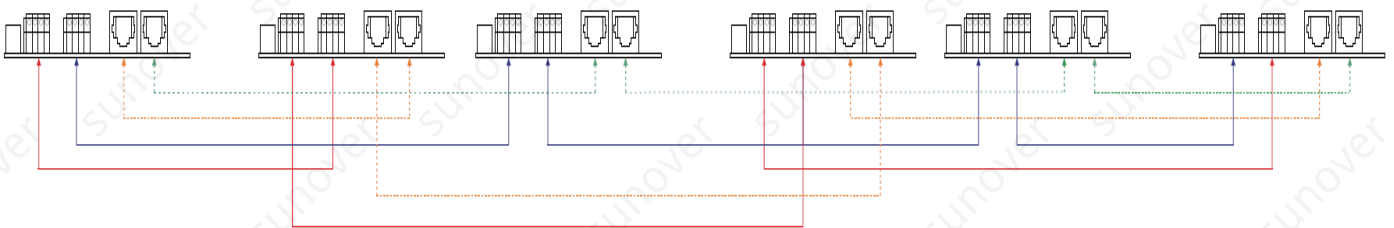

## Setting and LCD Display

Setting Program:

The parallel function setting can be set up through software or LCD setting #32. When setting through software, you can set the inverter one by one through USB or RS-232 port.

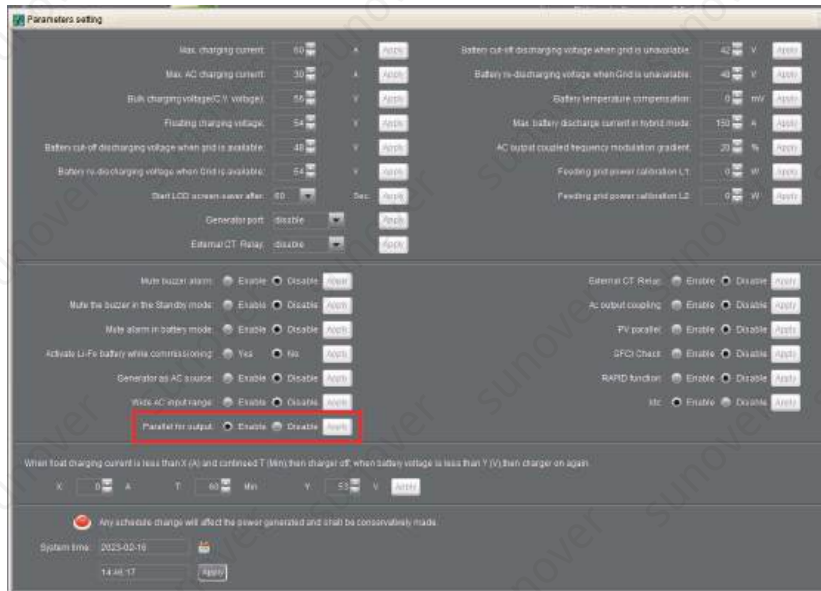

### Through software

Setting parallel for output in parameters setting, enable/disable.

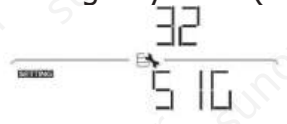

## Through LCD operation

In LCD program 32, you may select single or parallel.

32	Parallel for output	<p>Single: This inverter is operated in Single system. (default)</p> 	<p>Parallel: This inverter is operated in parallel system.</p> 
----	---------------------	---	--

## Commissioning

Step 1: Check the following requirements before commissioning:

- Correct wire connection.
- Ensure all breakers in Line wires of load side are open and each Neutral wire of each unit is connected together.

Step 2: Turn on each unit and set "enable parallel for output" on SolarPower or SolarPower Pro. And then, shut down all units.

Step 3: Turn on each unit.

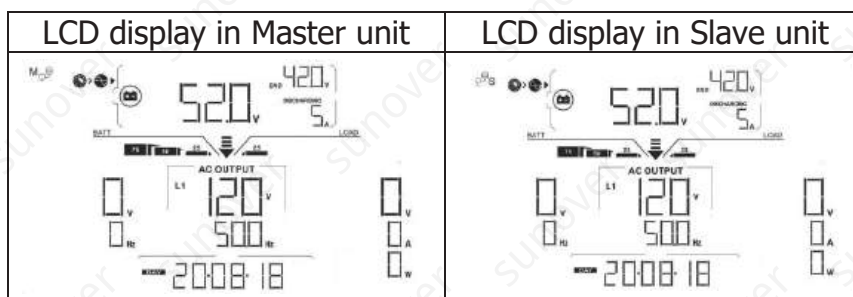

**NOTE:** Master and slave units are randomly defined. Warning 02 is AC GRID voltage low.

Step 4: Switch on all AC breakers of Line wires in AC input. It's better to have all inverters connect to utility at the same time. If not, it will display fault 82 in following-order inverters. However, these inverters will automatically restart. If detecting AC connection, they will work normally.

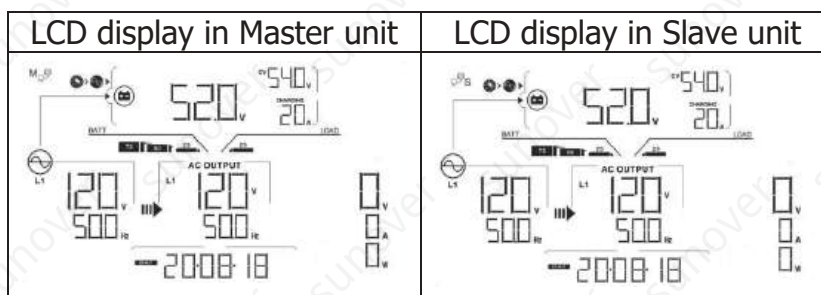

Step 5: If there is no more fault alarm, the parallel system is completely installed.

Step 6: Please switch on all breakers of Line wires in load side. This system will start to provide power to the load.

## Trouble shooting

Situation		Solution
Fault Code	Fault Event Description	
60	Current feedback into the inverter is detected.	<ol style="list-style-type: none"> <li>1. Restart the inverter.</li> <li>2. Check if L1/L2/N cables are not connected with wrong sequence in all inverters.</li> <li>3. Make sure the sharing cables are connected in all inverters.</li> <li>4. If the problem remains, please contact your installer.</li> </ol>
61	Relay board driver loss	<ol style="list-style-type: none"> <li>1. Disconnect all of power source.</li> <li>2. Only connect AC input and press the Enter key to let it working in bypass mode.</li> <li>3. Check if the problem happens again or not and feedback the result to your installer.</li> </ol>
62	Relay board communication loss	
71	The firmware version of each inverter is not the same.	<ol style="list-style-type: none"> <li>1. Update all inverter firmware to the same version.</li> <li>2. After updating, if the problem still remains, please contact your installer.</li> </ol>
72	The output current of each inverter is different.	<ol style="list-style-type: none"> <li>1. Check if sharing cables are connected well and restart the inverter.</li> <li>2. If the problem remains, please contact your installer.</li> </ol>
80	CAN data loss	<ol style="list-style-type: none"> <li>1. Check if communication cables are connected well and restart the inverter.</li> <li>2. If the problem remains, please contact your installer.</li> </ol>
81	Host data loss	
82	Synchronization data loss	

# Appendix II: The Wi-Fi Operation Guide

## 1. Introduction

Wi-Fi module can enable wireless communication between hybrid inverters and the monitoring platform. Users can remotely monitor and control their inverters when they combine the Wi-Fi module with i.Solar APP. The App uses the Wi-Fi chip to provide remote monitoring data services, which is beneficial for the daily data monitoring of the inverter, querying the real-time data in the device, sending commands from the device, and operating the device remotely. The app is available for both iOS and Android.



## 2. iSolar App

### 2-1. App Download and Installation

Operating system requirement for your smart phone:

🍏 iOS system supports iOS 12.0 and above

🤖 Android system supports Android 10.0 and above



You may find "i.Solar" app from the Apple® Store and Google® Play Store.

### 2-2. WiFi Model Setting

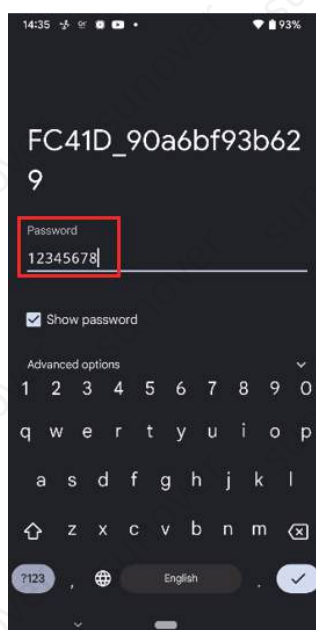
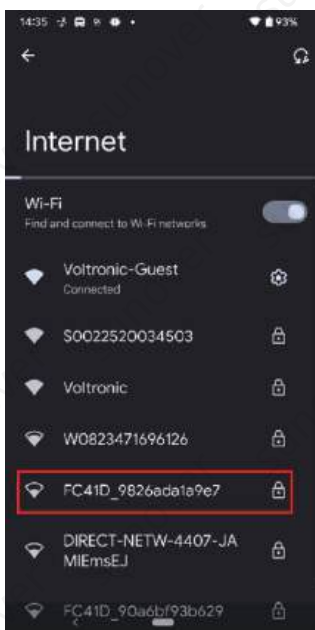

Step 1: Turn on your mobile device. This example uses the Android system.

Step 2: Open the mobile's Wi-Fi settings

Step 3: Connect your device to the Wi-Fi with the name that begins with "FC41D\_". The default password for this Wi-Fi is **12345678**.

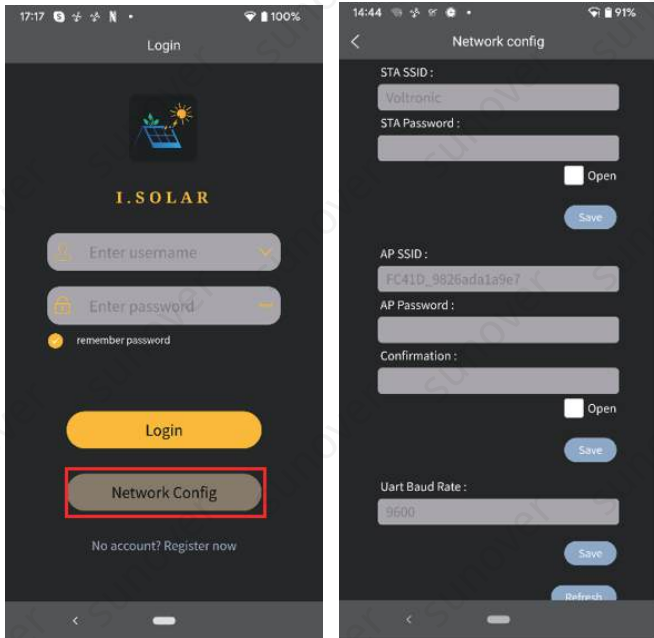

Step 4: After the Wi-Fi connection is successful, click the i.Solar App installed on the phone to enter the login page. Then, click the "Network Config" button to enter the Wi-Fi configuration page.

Step 5: After click the "Network Config" button to enter the Wi-Fi configuration page.

Step 6: Enter your router name (STA SSID) and router password (STA Password), then click the "Save" button to complete the setting.

If you check the "Open" box marked in red, you only need to enter the router name (STA SSID), you don't need to enter the router password. Click the "Save" button to complete the setting.

Step 7: Enter the Wi-Fi name (AP SSID) and Wi-Fi password (AP Password) of the Wi-Fi card, confirm the password again and click the "Save" button to complete the setting of the Wi-Fi module.

If you check "Open" marked in red, you only need to enter the Wi-Fi name (AP SSID), you don't need to enter the Wi-Fi password and Confirmation. Click the "Save" button to complete the setting.

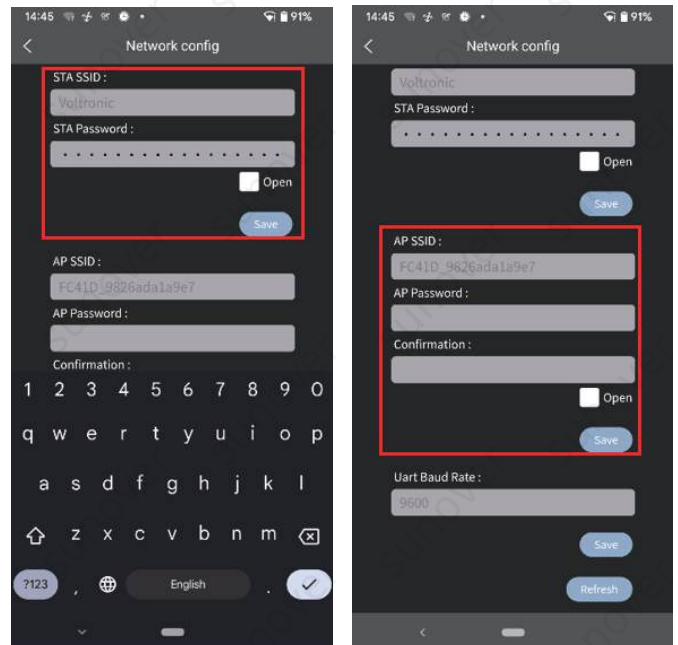

Step 8: After entering the value of the baud rate, click the "Save" button to complete the setting of Uart Baud Rate.

## 2-3 Login

After opening the app, enter the login page shown below. After filling in all required information (user name and password), click the "Register" button to complete the user registration. Once registration is complete, click "Click to log in" or return to the previous page. Swipe left or click the left arrow to return to the login page. Enter the user name and password to log in.

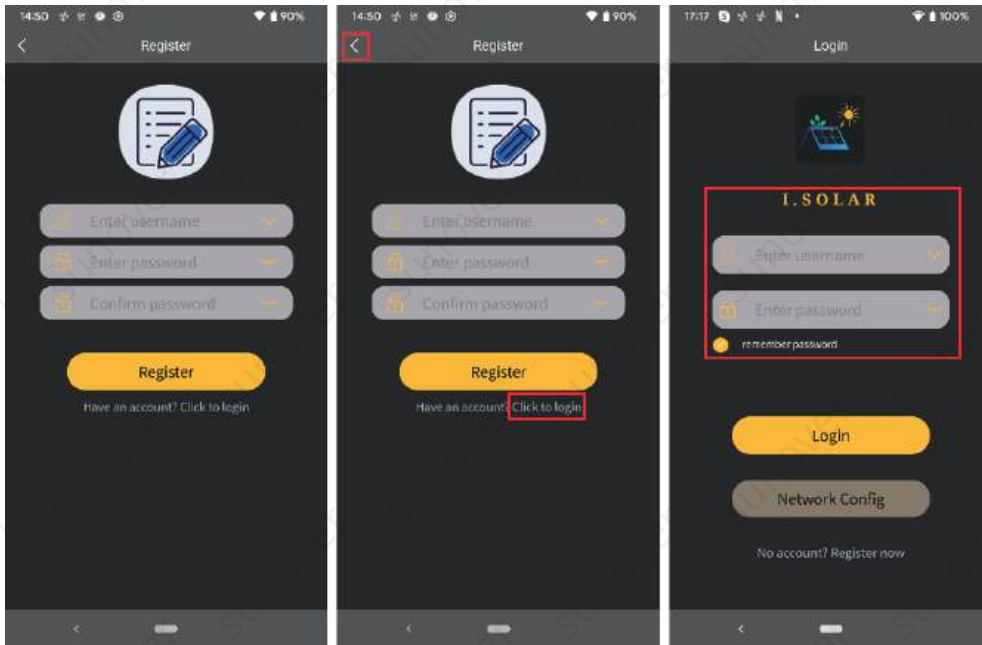

## 2-4 Home Page

Log in to enter the App. The default Home page will appear where you can view the charts (left screenshot). Click the button 'Day', 'Month', and 'Year' to query the power generation data. Click 'Total' to query the annual power generation data.

Tap the icon (located on the top right corner) to enter the page to add, delete or rename the device. Enter the device serial number to add the device.

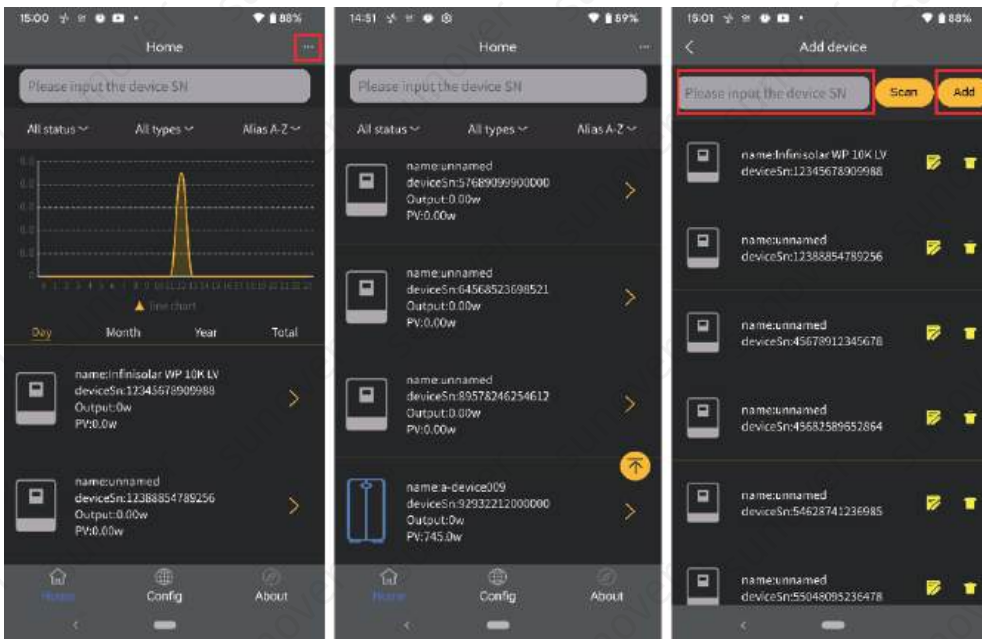

Rename (left screenshot) and delete (right) the devices by pressing the buttons highlighted by the red box.

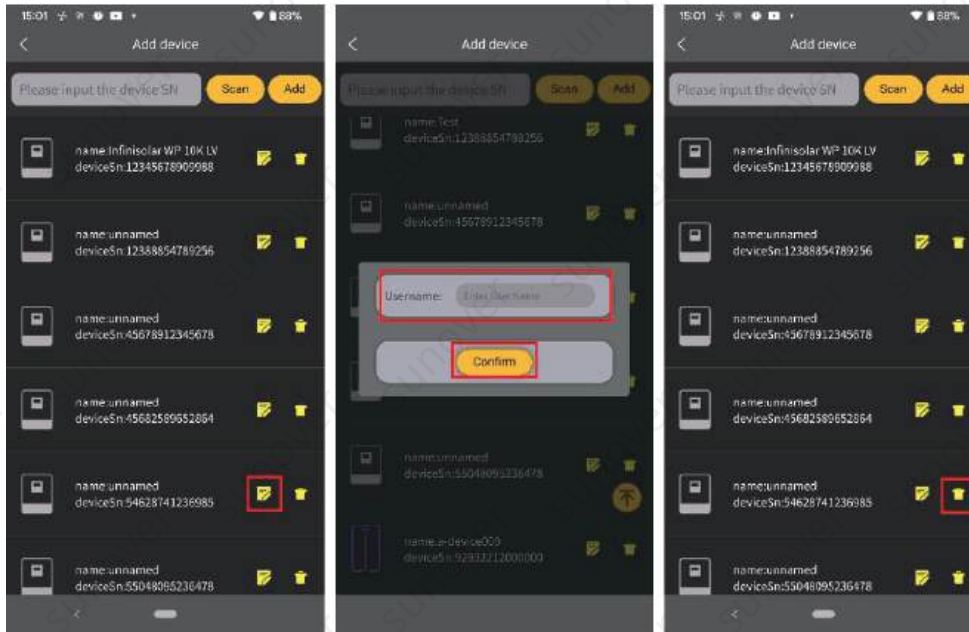

## 2-5 Real-time Data

'Energy' displays battery power, grid power, solar power, and load consumption. Rename the device by pressing the 'Rename' button.

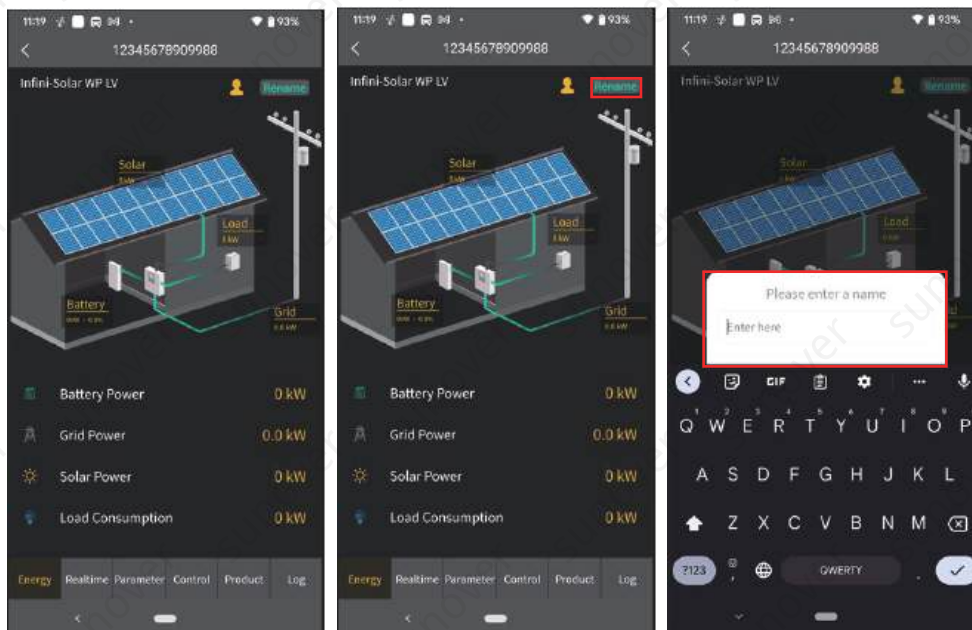

**'Real-time'** displays solar, grid, load, and battery information. Press 'Day', 'Month', or 'Year' to query the hourly, daily, or monthly power generation data. Press 'Total' to query the annual power generation data.

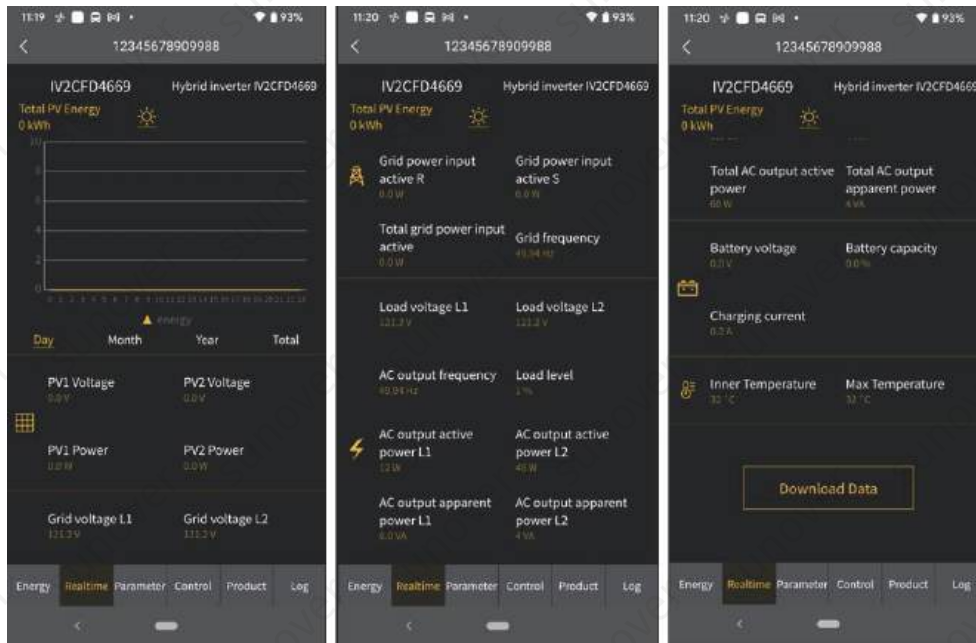

**'Parameter'** displays the setting items. Note that the setting items on the parameter page will be different for different models. Tap on the dropdown icon to select the setting and click the "Apply" button to change the setting

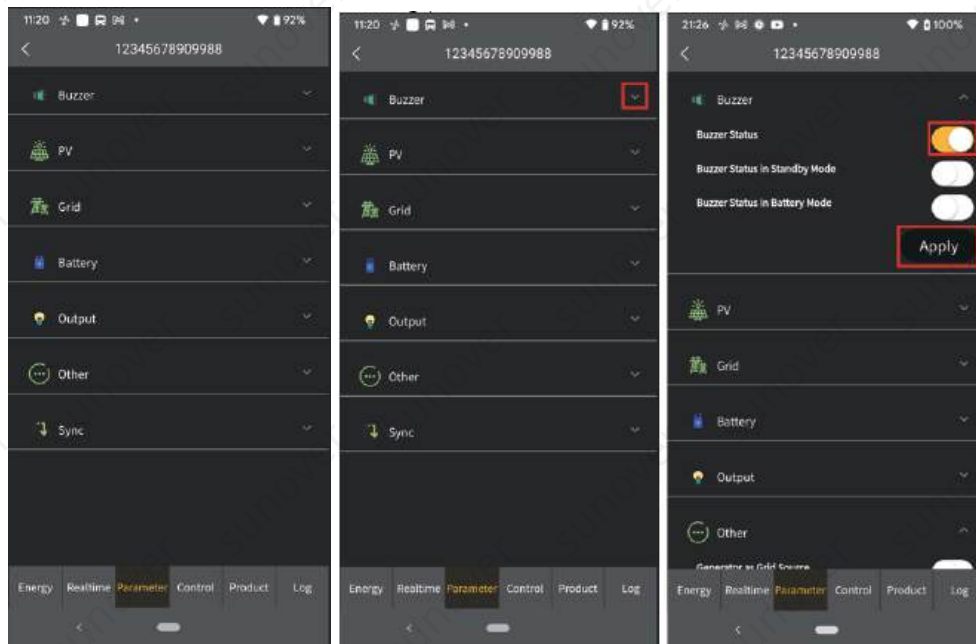

'Control' displays the power on/off for AC output power. 'Product' displays the product and rating information (right screenshot).

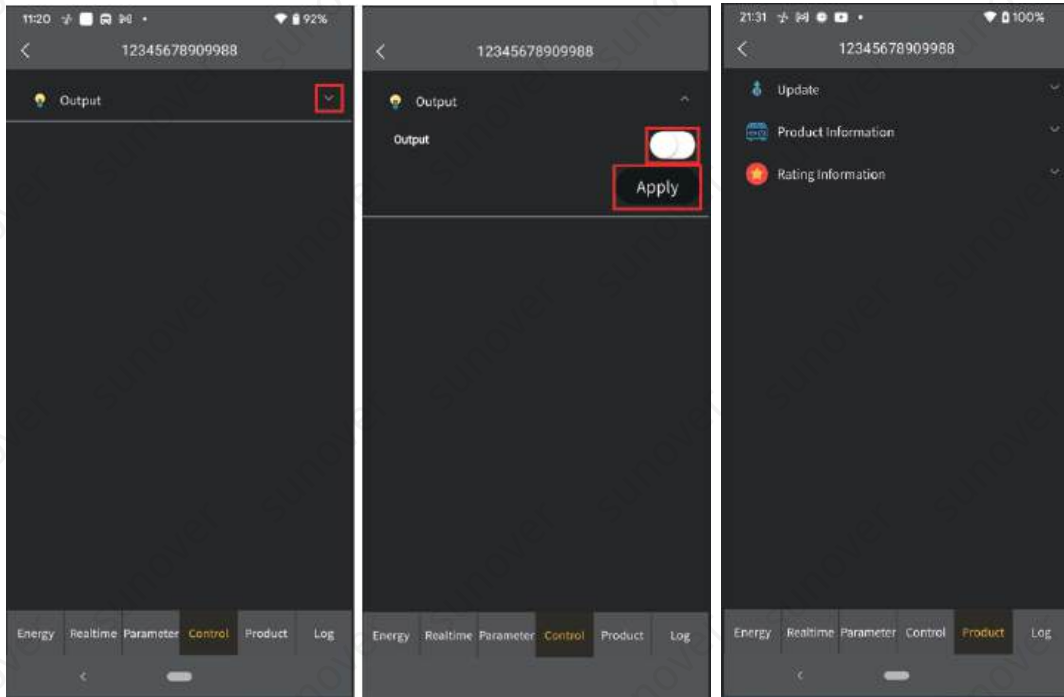

'Log' displays the data log, solar power generation log and event. The following are instructions on how to navigate through each of the options.

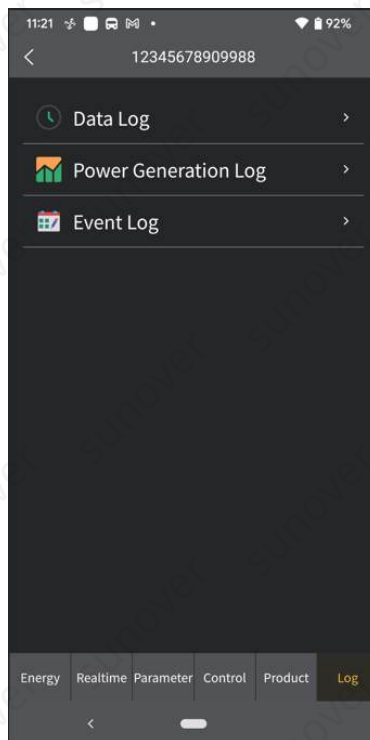

## Data log

Tap the time, select the date and click the "Browse" button to update log.

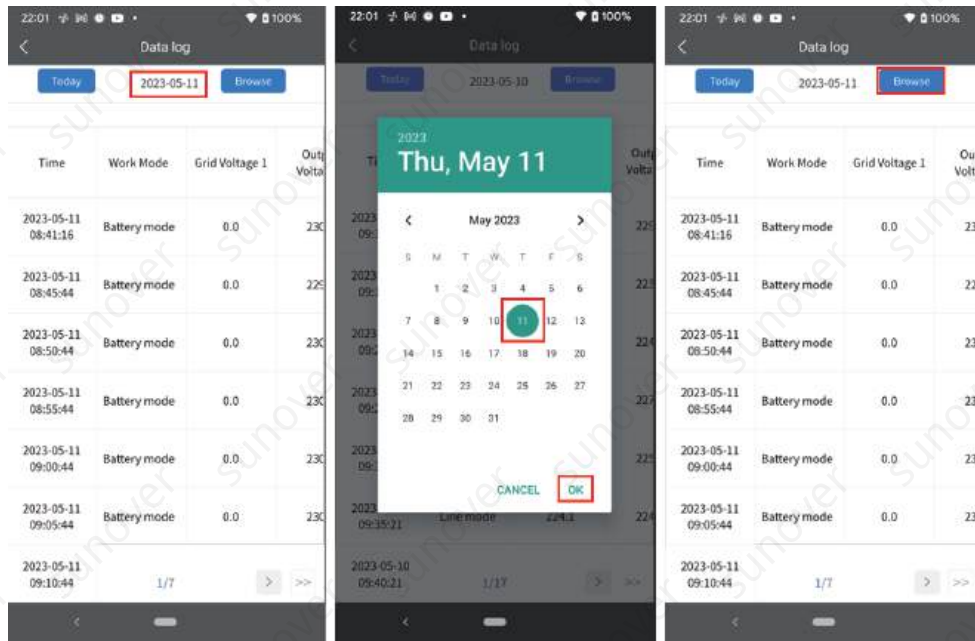

## Power Generation Log

Tap the time, select the day, month or year, and click the "Done" button to update log.

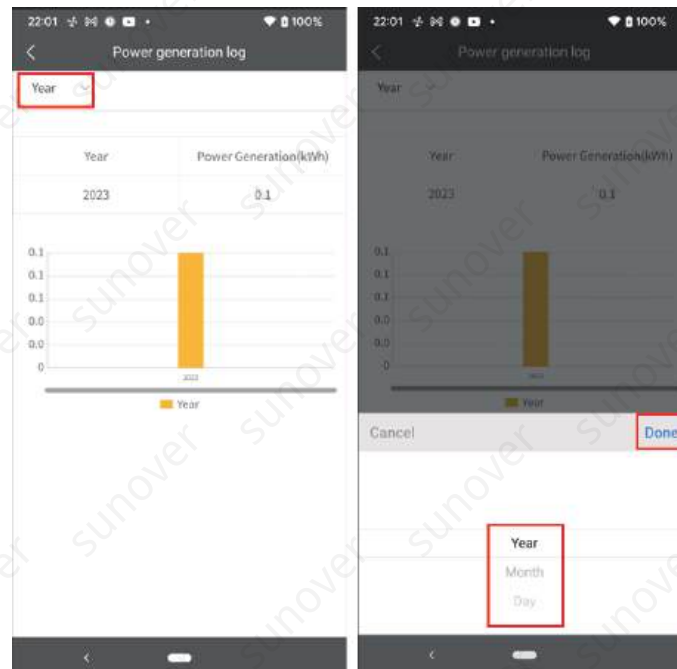

## Event Log

Tap the time, select the month and click the "Browse" button to update log.

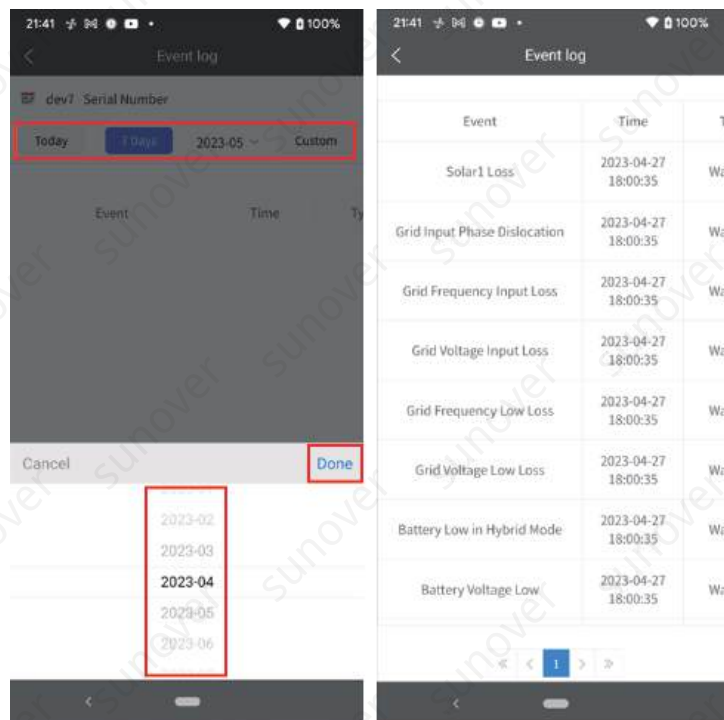

## 2-6 Configuration

Click the "Config" tab to enter setting screen. 'Change Password' by entering the old password, entering the new password, confirming the new password, and clicking the Apply button to complete the password modification function. 'Delete Account' by pressing delete account.

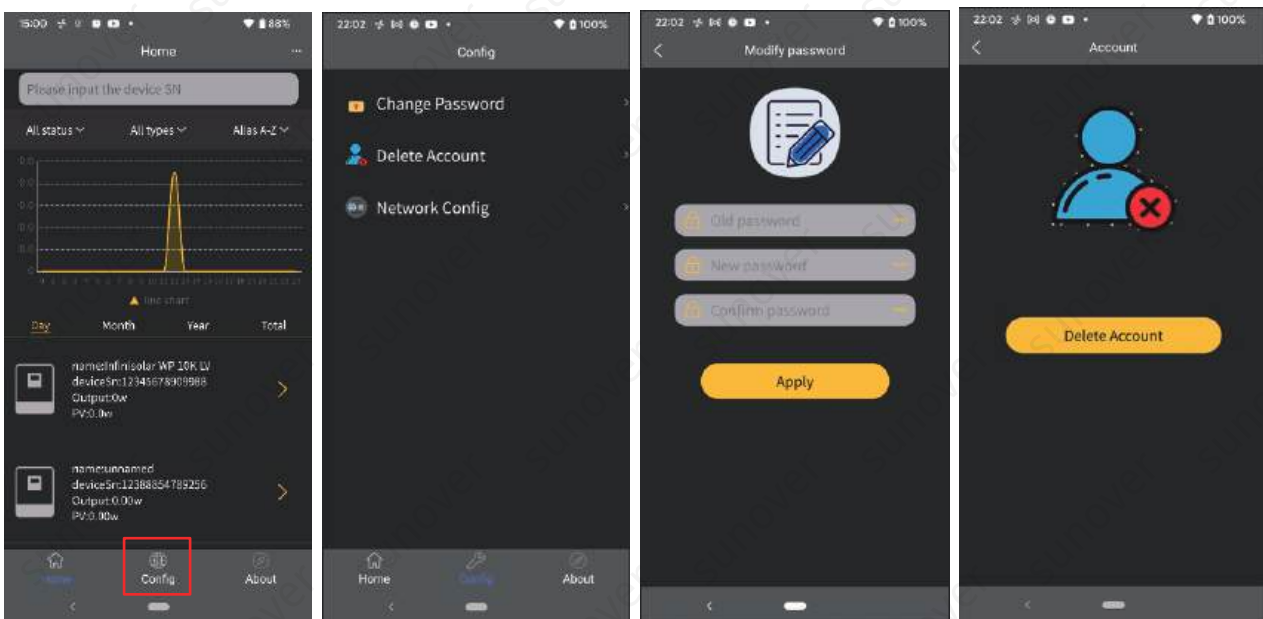

## 2-7 About

Click the 'About' tab to enter the about page, where you can view the information about the App.

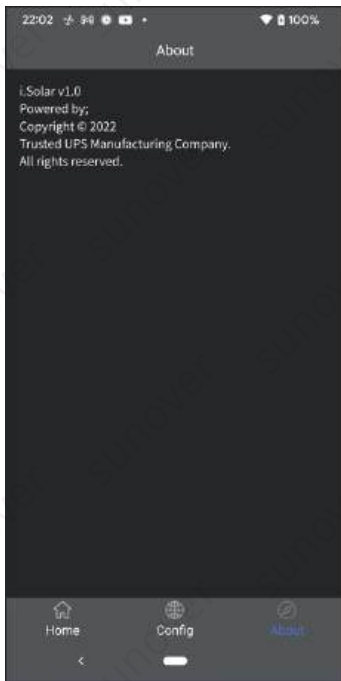

## Appendix III: The CT Operation Guide

With the CT connected, the hybrid inverter can be easily integrated into the existing household system. The CT can be used to control power generation and the battery charging of the inverter.

### Single commissioning

**Step 1.** Power off the inverter and connect the CT circuit according to the wiring diagram below.

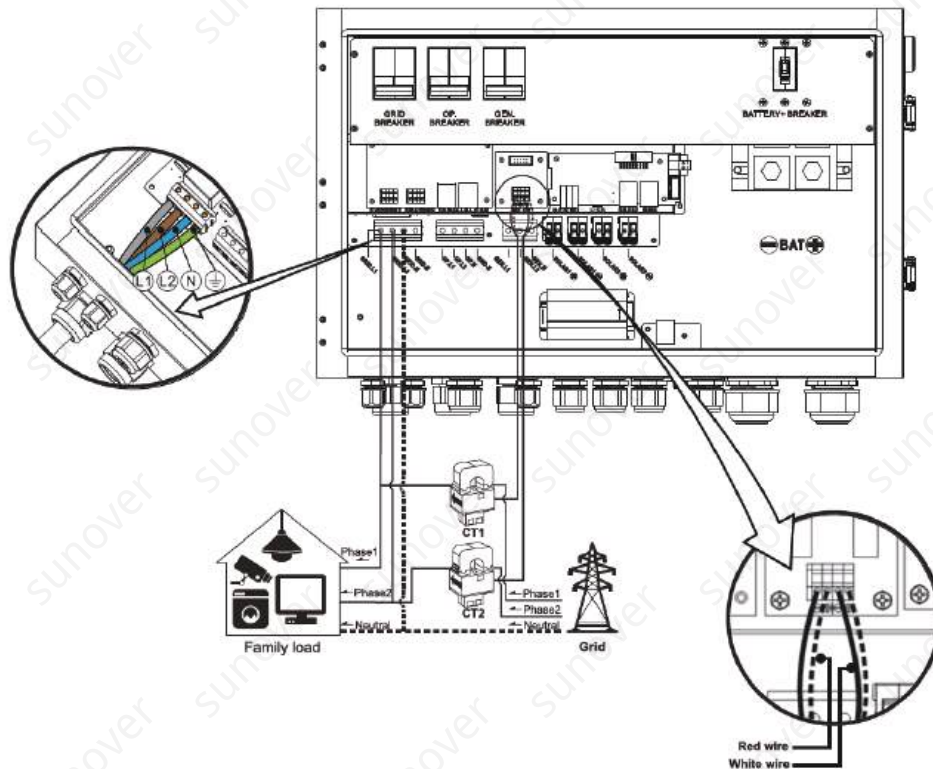

**Step 2:** Power on the inverter, wake up the LCD and modify LCD setting. Enter LCD program #13 and set up as any Grid-tie with backup mode. The CT will not be enable if not setting to grid-tie with backup.

**Step 3:** Enter LCD setting on the inverter with CT sensor connected and change program #36 to "enable".

36	External CT function	Disable (default) 36 CTd	Enable 36 CTE
----	----------------------	--------------------------------	---------------------

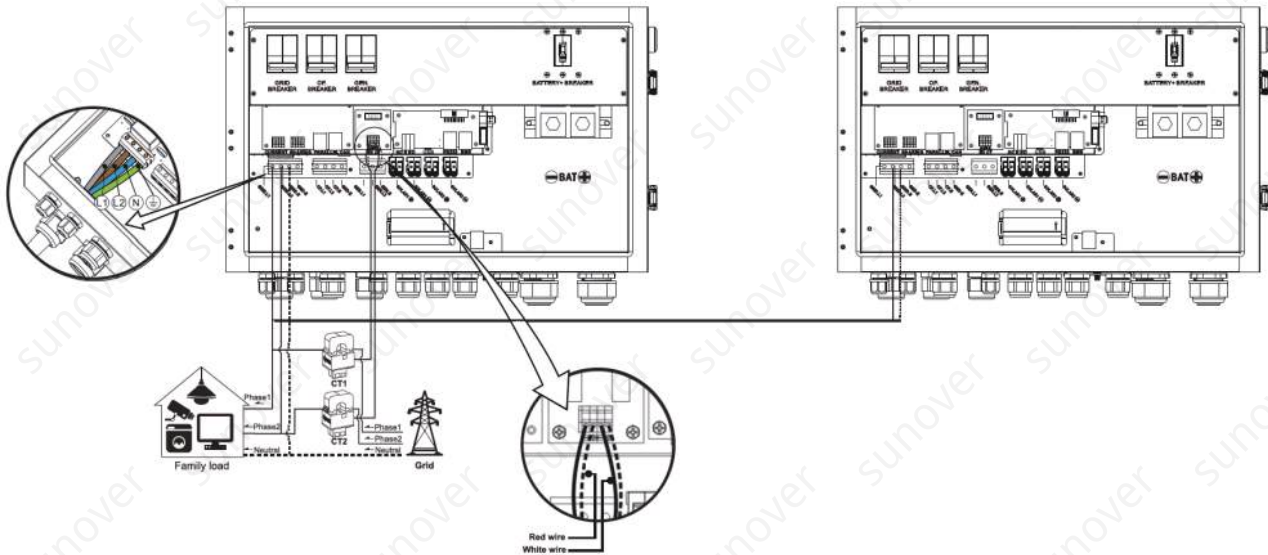

### Parallel commissioning

**Step 1.** Power off the inverter and connect the CT sensor according to the wiring diagram below. For other parallel circuits, please follow Appendix I.



**Step 2:** Power on all inverters, wake up the LCD and modify the Settings. Enter LCD program #13 and set up as any Grid-tie with backup mode. The CT will not be enabled if not setting to grid-tie with backup.

**Step 3:** Enter LCD setting on the inverter with CT sensor connected and change program #36 to "enable".

36	External CT function	Disable (default) 	Enable 
----	----------------------	--	---

**IMPORTANT ATTENTION:**

If applying CT function during parallel operation, it only needs one inverter from the parallel system connected to CT sensor. Be sure to enable LCD program #36 external CT function on the one inverter with CT connected and set up "Disable" on the remaining inverters. Otherwise, it will cause CT function not working during parallel operation.

## Software setup

In addition to LCD operation, you also can setup through software. Refer to the software screen below. Enter "Parameters setting" to enable "External CT relay".

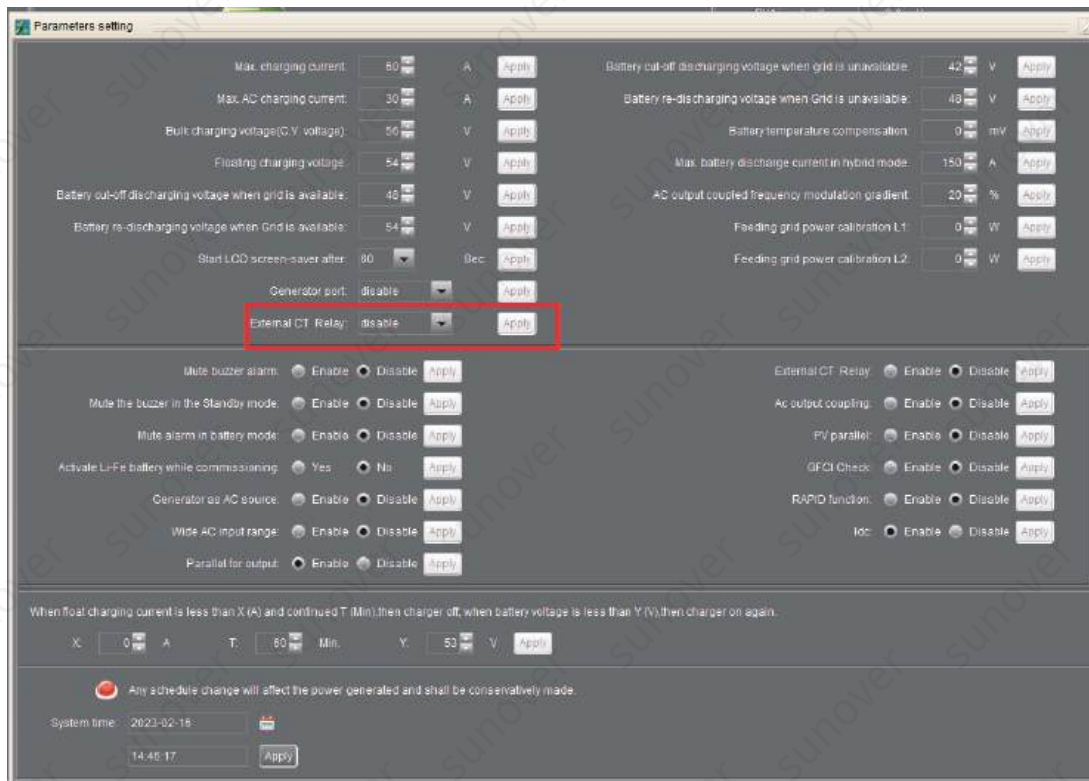



After CT function is enabled, program# 14 will be automatically changed to HBD2, program #15 will automatically set to turn off AC charging, and program #16 will disable the feed-in function.

## Appendix IV: The Generator Operation Guide

Through the generator port, the inverter can realize multiple groups of redundant backup power supply. In the absence of grid or solar power, users have the option of using a generator to charge the battery and power the load. Follow below steps to activate this function:

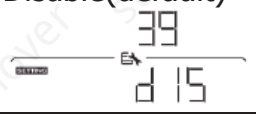
**Step 1.** Turn on the inverter and enable generator port function in LCD program #39 (Select "GEN").

39	Generator port Function	Disable(default) 	If selected, the input of generator port will be disabled.
		Enable 	If selected, generator port will be activated.

After setting, " **APL** " icon will flash on LCD display.

**Step 2:** You need to turn on the AC output of the inverter. The generator can only be used in battery mode. Once the generator port function is activated and the power input of generator enters the inverter, " **APL** " icon will be illuminated and the input voltage/input frequency will show on the LCD display.

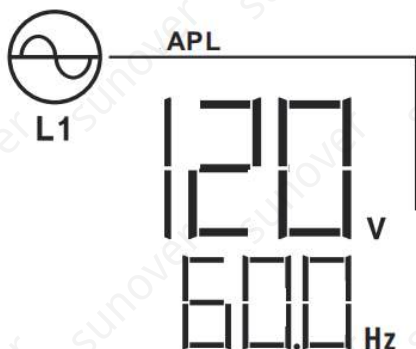

### NOTE:

1. When the generator is in use, the inverter will force the battery to charge.
2. When the generator is in use, the maximum charging current of the inverter will be limited to 100A, and the user can choose a lower charging current by setting LCD program #05.
3. The generator will be used when the power grid is lost. If the power grid is restored, the generator will stop being used.